



INSTALLATION & USER GUIDE FOR THE

BIOROCK SYSTEMS:

ECOROCK-1500

ECOROCK-2000

ECOROCK-3000



TABLE OF CONTENTS

A.	INSTALLATION GUIDE	5
B.	USER GUIDE.....	23
C.	APPENDICES	34



Dear Customer,

Congratulations on your purchase of this BIOROCK® Domestic Sewage Treatment Plant. Your new BIOROCK will guarantee years of trouble-free operation, peace of mind and protection for the environment.

We highly recommend that you familiarize yourself with this guide for the installation, commissioning and maintenance of your new BIOROCK system.

The instructions for the maintenance and visual checks of the system will ensure that you have a reliable and long-lasting sewage treatment plant.

Please do not hesitate to contact your BIOROCK distributor for any queries or further assistance. Thank you for choosing BIOROCK.

READ CAREFULLY

The installation and commissioning of your BIOROCK® system should be carried out by a BIOROCK trained and approved installer. Your installer will be able to offer you a maintenance contract. The BIOROCK Warranty is only valid if the required maintenance is carried out by a BIOROCK trained and approved installer. Should you not wish to take out a maintenance contract, make sure you have your sewage treatment plant inspected and maintained on a regular basis by an industry trained, competent wastewater professional.

BIOROCK S.à.r.l.

Z.A.E. Robert Steichen
5, Rue Bommel
L-4940 HAUTCHARAGE
Luxemburg

E-mail: info@biorock.com
Telephone: +352-26-17 66 33

Distributor's name:

Contact person:

Address:

E-mail:

Telephone:



A. INSTALLATION GUIDE

ECOROCK SYSTEMS

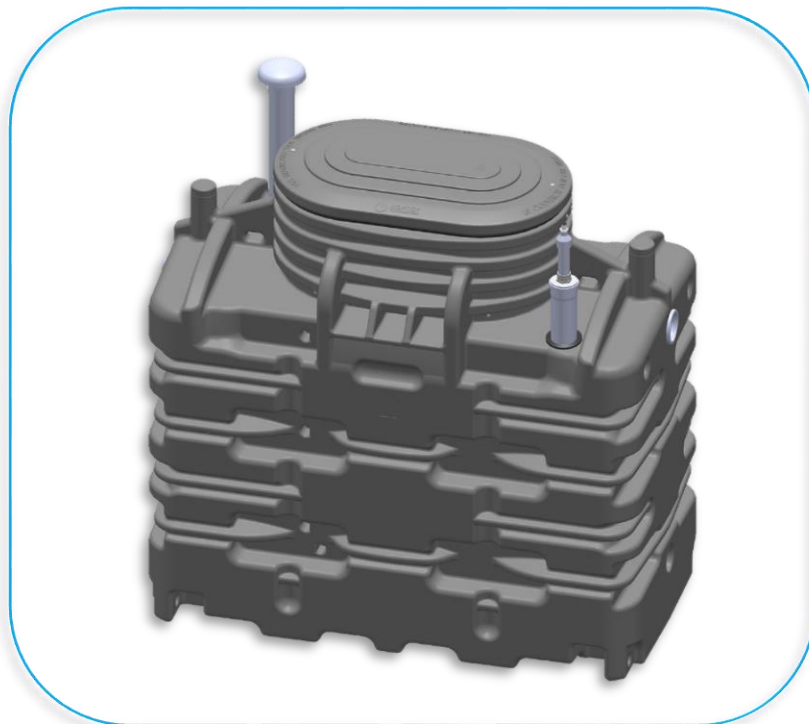

TABLE OF CONTENTS

1. THE BIOROCK SEWAGE TREATMENT SYSTEM	6
1.1. General points	6
1.2. Sizing	6
1.3. Precautions	6
1.4. Identification	7
1.5. Handling and transport	7
2. OPERATING PRINCIPLES OF YOUR BIOROCK® SYSTEM	8
2.1. Primary Tank – Operating principle.....	8
2.2. BIOROCK® Treatment Unit – Operating principle	9
2.3. BIOROCK® Treatment Unit – Technical	9
3. INSTALLATION LAYOUTS	10
3.1 Installation layout n°1.: Gravity discharge (non-electric).....	10
3.2 Installation layout n°2.: Pumped discharge (pump after PT)	10
3.3 Installation layout n°3.: Pumped discharge (pump after BIOROCK® unit)	10
4. INSTALLATION OF THE TANKS	11
4.1 Principles and constraints of installation works.....	12
4.1.1 <i>Before installation of the complete system</i>	12
4.1.2 <i>Installation of the Primary Tank</i>	12
4.1.3 <i>Installation of the BIOROCK® treatment unit</i>	12
4.2 Installation in dry ground conditions	13
4.2.1 <i>Installation and digging in dry ground conditions</i>	13
4.2.2 <i>Installation of the Tanks in dry ground conditions</i>	14
4.2.3 <i>Backfilling in dry ground conditions</i>	14
4.3 Installation in wet ground conditions.....	14
4.4 Installation in specific sites.....	16
4.4.1 <i>Installation in difficult areas and sites</i>	16
4.4.2 <i>Installation in difficult ground conditions</i>	16
4.4.3 <i>Backfilling in difficult sites</i>	16
4.5 Installations under roads, courtyards or storage areas.....	17
4.6 Other specific cases	17
4.6.1 <i>Incline too steep</i>	17
5. VENTILATION AND WATER DISTRIBUTION	18
5.1 Ventilation of the Primary Tank.....	18
5.2 Ventilation of the BIOROCK® treatment unit	19
5.3 Water distribution	19
5.4 BIOROCK® media	20
5.5 Securing the lids.....	20
6. STOPPING AND RESTARTING THE SYSTEM	21
7. CONFORMITY AND WORK COMPLETION	21
8. RECOMMENDATIONS OF USE AND MAINTENANCE	21
9. COMPLIANCE WITH REGULATIONS AND STANDARDS	21
10. WARRANTY	22



1. THE BIOROCK® SEWAGE TREATMENT PLANT

1.1 GENERAL POINTS

The ECOROCK SYSTEMS from BIOROCK are compact non-electric Sewage Treatment Plants. The treatment relies on the revolutionary BIOROCK® biological purification process. The ECOROCK sewage treatment unit is exclusively designed for domestic waste water purification.

The BIOROCK® plant consists of a Primary Tank and a ECOROCK Bioreactor. Both parts (Primary Tank and Bioreactor) must be ventilated.

A small pump can be installed in a pump shaft downstream of the system to lift the treated water and discharge to a higher level if needed.

BIOROCK® recommends the installation of an effluent sampling at the outlet of the treatment unit.

The ECOROCK treatment unit can be installed (retrofitted) after a non-BIOROCK Primary Tank, provided that this tank is properly sized, equipped with an efficient effluent filter and properly vented.

1.2 SIZING

The ECOROCK units have a capacity of 6, 10, 15 and 30 P.E. (Person Equivalent). This manual is for the ECOROCK-1500, 3000. The capacity of the individual ECOROCK unit can be increased if the required final effluent quality is of a lower standard than the results, achieved during the EN-12566-3 Performance test.



1.3 PRECAUTIONS

Important precautions for the proper use of the BIOROCK® system: Only domestic sewage should enter the system; no rainwater is allowed.

To ensure the good working order of the BIOROCK® system, the use of automatic toilet cleaners, electric waste-disposal systems and pumps equipped with blades are not to be used.

If there is a professional kitchen on site, a grease trap should be installed. The grease trap should be installed before the primary tank.

Do not dispose of the following items to the BIOROCK® system:

Kitchen or motor oils, fats, wax, resin, paint, solvents, hydrocarbon-based products (petrol, crude oil etc.), any pesticide or antibacterial product, items of a toxic nature, boiler or air-conditioning condensate, swimming pool backwash, rainwater, drainage water or ground-water.

An effective effluent filter should be installed in the outlet of the Primary Tank, before the water goes on to the Bioreactor.

We recommend that every ECOROCK unit should be equipped with a sampling pipe.

Special care should be taken with the aeration of the system. The aeration should be checked by the installer with a smoke test. The smoke test should be performed under normal representative conditions.

Each unit should be vented independently and equipped with its own ventilator (wind driven or electrical). Limit the number of elbows used (never use 90° elbows, only use 45° elbows).

The high air outlets should be installed as close as possible to the low air inlets.

Achieving efficient ventilation is the responsibility of the installer. The installer understands the local conditions.

The Primary Tank should de-aerated separately in accordance with the manufacturer's instructions.



1.4 IDENTIFICATION

Before installing please copy the serial number of each tank on to the documents to be kept by the customer (Appendix 5 of this Guide.)

When looking at the tank facing the BIOROCK® logo, the serial number is:

- On an identification tag inside the tank, and /or

Marked  as on the drawing below

- Engraved on the area to your right at the bottom of the rounded top.

Marked  as on the drawing below

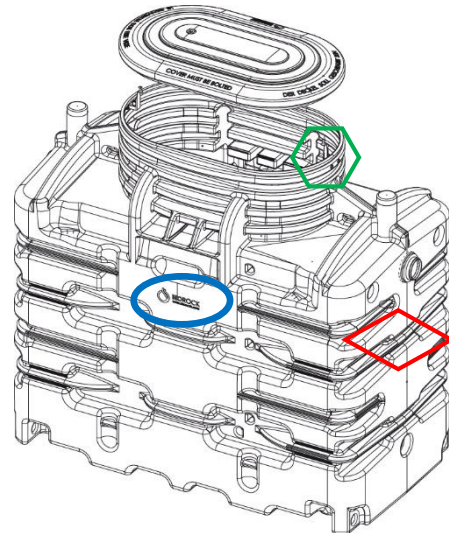

M Detail of the identification plate inside the tank:



1.5 HANDLING AND TRANSPORT OF THE TANKS

Two integrated slots on the bottom of the tank enable a safe movement by fork lift.

Four lifting eyes are situated on the top corners of each tank, enabling lifting by crane or JCB.

The tanks should be handled, transported and stored with care after delivery to avoid being damaged.



2. Operating principle of an ECOROCK® Sewage Treatment Plant

2.1 THE PRIMARY TANK

2.1.1 Ventilation of the Primary Tank

Any Primary tank should have a proper unencumbered low level and high level vent. The low level vent should be connected directly on the outlet side of the tank and the high level on the inlet side and should not be positioned more than 10 m¹ from the tank and at a minimum height of 4 m¹ with a wind driven ventilator also fitted. The water inlet should be made air tight. All ventilation should be checked with a smoke test.

2.1.2 Performance of the Primary Tanks (PT)

If you don't use a Primary Tank of BIOROCK, you have to make sure that the quality of the effluent of the PT meets the BIOROCK requirements. A proper ventilation of a PT is necessary, not only to avoid smell problems, but also to evacuate the produced gasses. A Primary Tank generates malodorous gases like sulfur hydrogen (H₂S). An evacuation of the gasses is necessary to avoid that H₂S will be transformed into harmful sulfuric acid (H₂SO₄). sulfuric acid will harm the biological process and can cause degradation of the BIOROCK Media.

BIOROCK claims the following performance of a PT in front of a BIOROCK unit:

Composition of normal domestic wastewater (according to EN12566-3+A2 Annex B.3.2):		
	Variation	
BOD ₅ * ¹ :	150 - 500	mg O ₂ /l
COD* ¹ :	300 - 1000	mg/l
S.S.:	200 - 700	mg/l
KN:	25 - 100	mg/l
NH ₄ -N:	22 - 80	mg/l
P-Total:	5 - 20	mg/l

*¹: The ration between BOD₅ and COD should always be < 2

Minimum performance requirements of a Primary Tank* ² :			
	Effluent PT		Average
	EN 12566-6: 2008		
BOD ₅ :	100 - 350	mg O ₂ /l	200 ± 50 mg O ₂ /l
COD:	200 - 600	mg/l	
S.S.:	40 - 150	mg/l	80 ± 20 mg/l
KN:	35 - 100	mg/l	
NH ₄ -N:	30 - 80	mg/l	
P-Total:	4 - 20	mg/l	

*²: The sampling should be done with a minimum 24 hour sampling

The effluent is easy biodegradable if the ratio of BOD₅ and COD is less than 2. Between 2 and 3 it is partially biodegradable and greater than 3, the effluent is not biodegradable.



2.2 THE BIOROCK TREATMENT UNIT (Bioreactor) – ECOROCK

The ECOROCK sewage treatment units are biological purification systems, using the BIOROCK® media as a carrier material for bacteria. An ECOROCK unit consists of two biological filtration stages and one aeration stage, has pre-treated water passed through it by gravity. The pre-treated water is spread over the surface of the first layer of BIOROCK® media by a distribution system and penetrates into the media for purification.

The treated water discharging from the unit must flow by gravity to the next stage or a discharge point.

2.3 ECOROCK TREATMENT UNIT – TECHNICAL

- ◆ The tanks and covers are made of polyethylene
- ◆ Each tank has two lifting eyes that are situated at the middle of the tank
- ◆ The water inlet has a \varnothing of 110 mm
- ◆ Air inlet and air outlet have a \varnothing of 110 mm
- ◆ The water outlet has two possible diameters; \varnothing 75 and \varnothing 110 mm
- ◆ Each unit has a serial number that is located on the right side of the tank (*A/Chapter 1.3*)
- ◆ All materials in the BIOROCK® plants are resistant to corrosion and guarantee a long-term lifespan
- ◆ The tanks are made by rotational molding in HDPE (High Density Polyethylene)
- ◆ The tanks are UV resistant and have a lifespan of at least 25 years
- ◆ The HDPE tanks are 100% recyclable
- ◆ The screws are made of stainless steel
- ◆ The pipes are made of PVC and Polypropylene
- ◆ The entire system is nearly 100% recyclable



3. Installation layouts

The installation of the BIOROCK® system depends on the available site, gradient, type of ground, the level of the water inlet and the discharge options.

When the outlet for final effluent is not accessible, a sampling shaft should be installed. When using a final effluent pump the pump shaft can be used as a sampling shaft.

3.1 INSTALLATION LAYOUT N°1 GRAVITY DISCHARGE (non-electric)



3.2 INSTALLATION LAYOUT N°2 PUMPED DISCHARGE, PUMP AFTER THE PRIMARY TANK



3.3 INSTALLATION LAYOUT N°3 PUMPED DISCHARGE, PUMP AFTER THE ECOROCK® TREATMENT UNIT



4. INSTALLATION OF THE TANKS

This chapter provides a guide to the installation and commissioning of the BIOROCK® system. This manual cannot be a substitute for documentation and instructions from manufacturers of non-BIOROCK® products integrated into the system by the user.



Please take photographs of each stage of the installation with particular attention to all of the connecting pipework



**DO NOT completely fill the tanks with water before unit is backfilled
DO NOT use dirty or contaminated water**



DO NOT use a mechanical compactor, only compact manually



DO NOT reuse the excavated soil or spoil from the site



**DO NOT install the system too close to the house or other buildings
DO NOT install the system too close to large trees**

4.1 INSTALLATION PRINCIPLE

Dimensions and weight of the ECOROCK treatment units:

ECOROCK-1500	Value	Measure
Capacity in Person Equivalent (PE) ^{*1}	6	PE
Volume of the ECOROCK-5000 unit	1.500	Litres
Length of the Tank	1.150	mm
Width of the Tank	1.150	mm
Height of the Tank	2.175	mm
Height difference water inlet – water outlet	1.098	mm
Total weight (empty) of the ECOROCK-5000 unit	186	Kg
Pipe diameters	110	mm
Cover (round)	Ø 700	mm



ECOROCK-2000	Value	Measure
Capacity in Person Equivalent (PE) ^{*1}	10	PE
Volume of the ECOROCK-2000 unit	2.000	Litres
Length of the Tank	1.450	mm
Width of the Tank	1.150	mm
Height of the Tank	2.075	mm
Height difference water inlet – water outlet	1.098	mm
Total weight (empty) of the ECOROCK-2000 unit	241	Kg
Pipe diameters	110	mm
Cover (round)	Ø 700	mm

ECOROCK-3000	Value	Measure
Capacity in Person Equivalent (PE) ^{*1}	15	PE
Volume of the ECOROCK-3000 unit	3000	Litres
Length of the Tank	2.150	mm
Width of the Tank	1.150	mm
Height of the Tank	2.075	mm
Height difference water inlet – water outlet	1.098	mm
Total weight (empty) of the ECOROCK-3000 unit	304	Kg
Pipe diameters	110	mm
Cover (oval)	Ø 700-1.250	mm

^{*1} The capacity of the ECOROCK units can be decreased or increased if the required effluent quality is of a higher or lower standard than the results, achieved during the EN-12566-3 Performance test.

4.1.1 Before the installation of the complete system

- ◆ Always keep the system accessible
- ◆ Check the tanks and the associated equipment (internal reinforcements, connections, seals, etc.) before installation, see technical details for each tank
- ◆ A minimum distance of about 3 m¹ from the house and 3 m¹ from trees which have extensive roots should be ensured
- ◆ A minimum distance of 2.5 m¹ from any building should be ensured, otherwise the stability of the building should be checked
- ◆ The installation should be located away from any traffic areas and parking (at least 2 m¹)
- ◆ The installation of the BIOROCK® system is possible in high ground water conditions if special Precautions are taken
- ◆ Consult a professional engineer if the units are to be installed with extension sets
- ◆ System lids should not be buried and should always remain accessible for maintenance
- ◆ The minimum distance between the primary tank and the treatment unit is 300 mm
- ◆ The distance between the side of the excavation and the tanks must be minimum of 300 mm
- ◆ Connections for the BIOROCK® system are made with flexible seals with a diameter of 110 mm
- ◆ Local rules and legislation should be respected

4.1.2 Installation of the Primary Tank

- ◆ The Primary Tank must be installed as close as possible (less than 10 m¹) to the wastewater discharge point of the property; this avoids fats clogging in the inlet pipe. With a longer pipe run from the property to the primary tank the installation of a grease trap may be necessary
- ◆ This 110 mm diameter pipe (100 mm minimum, 160 mm maximum) should have a minimum gradient of 2 % and a maximum of 4%



- ◆ The Primary Tank should always discharge by gravity into the BIOROCK® system
- ◆ Install the Primary Tank allowing a gradient towards the BIOROCK® system
- ◆ The Primary Tank should be installed away from any traffic area, unless special precautions are in place



The Primary Tank must be equipped with an efficient Effluent Filter

❖ Installation of a Pump Well

If the effluent can't be discharged by gravity, install a pump well & pump. The pump is required to lift the effluent (purified water) to a higher level.

BIOROCK® has developed an optional PE pump well with a diameter of 400 mm. The PE pump well has the same height as the ECOROCK unit. All the connections are matching with the openings at the ECOROCK units.

At the end of the BIOROCK® Reactor the purified waste water (effluent) is collected in the pump shaft and can be easily pumped to a higher level with a normal submersible pump.

- ◆ The seals on the BIOROCK® tanks are flexible and have a diameter of 110 mm
- ◆ The discharge pipe for the treated effluent should have a minimum gradient of 1%
[4.1.3 Installation of the BIOROCK® treatment unit](#)
- ◆ The BIOROCK® unit must be installed downstream of the Primary Tank
- ◆ The effluent from the Primary Tank should flow by gravity to the BIOROCK® unit
- ◆ The gradient of the treated effluent pipe to the BIOROCK® unit should be a minimum of 1%

4.2 INSTALLATION IN DRY GROUND CONDITIONS

See Appendix «Installation in dry ground conditions»

❖ Conditions for installation:

- Dry and stable ground conditions
- Absence of water at the bottom of the excavation

[4.2.1 Installation and digging in dry ground conditions](#)

- ◆ The maximum level of top soil above the backfill is 200 mm
- ◆ The units must stand on a clean and stable base such as concrete
- ◆ In dry ground conditions pea gravel can be used
- ◆ Mud and other soft materials must be removed from the bottom of the excavation prior to installation
- ◆ A stable base must be created at the bottom of the excavation
- ◆ The base of the excavation should be level and compacted
- ◆ There must be a distance of at least 300 mm between the walls of the excavation and the units



4.2.2 Installation of the tanks in dry ground conditions

- ◆ Once the base of the excavation is stable, the installation can begin
- ◆ The Primary Tank should not be positioned horizontally; it must have a slight gradient towards the water outlet
- ◆ Before connecting any water or ventilation pipes, ensure that the units are perfectly installed
- ◆ Ensure that all levels are correct so that the wastewater can flow freely through the system
- ◆ Check that all connections are correctly positioned
- ◆ Ensure that the seals are watertight

4.2.3 Backfilling in dry ground conditions

- ◆ Backfill the hole with 3 to 6 mm smooth pea gravel, or lean-mix concrete whilst filling the tanks with water at the same level
- ◆ Do not exceed 300 mm per filling and compaction cycle
- ◆ Make sure that the BIOROCK® media is completely saturated with water
- ◆ Do not backfill with the soil removed during the excavation: roots and stones can damage the tank.
- ◆ Do not compact the backfill material mechanically: compact manually.
- ◆ Backfilling around and filling both the Primary Tank and BIOROCK® unit with water should take place at the same time.
- ◆ Once the backfilling is finished and compacted, check the levels of the tanks again
- ◆ The lids or access covers of the system should be installed just above ground, level to provide easy access for maintenance.
- ◆ Close and secure all covers with screws
- ◆ Complete the backfilling once all pipework has been checked and connected.

4.3 INSTALLATION IN HIGH GROUND WATER CONDITIONS

Appendix «Installation in high ground water conditions»

The ECOROCK units can be installed in high ground water conditions with special precautions. If you don't use a BIOROCK® Primary Tank, please confirm with the other manufacturer that this Primary tank is suitable for high ground water conditions.



If you don't use a BIOROCK® Primary Tank, please consult the manufacturer to ensure this Primary Tank is suitable for high ground water conditions.



The level of the water table must never exceed the level of liquid inside the Primary Tank. Extremely high water tables signify a flood risk which could cause water ingress or collapsed tanks.



Perform the same work as in dry ground conditions with the additional recommendations and modifications below:

- ◆ For installations in a high water table area, ensure the adequate drainage of the excavation during installation
- ◆ Anchor the unit to the concrete slab (slab thickness should be a minimum 150 mm)
- ◆ The base must extend to a minimum distance of 300 mm beyond the base of the tanks on all sides
- ◆ If you are unsure, a qualified civil engineer should be consulted
- ◆ Anchoring the tanks to the base is achieved with a system using the anchoring points; these are positioned on the lower corners of the tanks



For installations in a high water table area, ensure the adequate drainage of the excavation during installation and anchor the unit to the concrete slab

Important:

- ◆ The tanks should be secured and anchored to the concrete base
- ◆ In all high ground water conditions, the backfilling should be carried out to a level of 20 cm below the tank covers.
- ◆ We recommend that the tanks are backfilled with (lean mix) concrete instead of a regular backfill



4.4 INSTALLATION IN «DIFFICULT» AREAS AND SITES

❖ Conditions of installation:

- ◆ Difficult ground conditions can be unstable ground, clay, rocks, etc.
- ◆ If necessary, ensure the adequate drainage of the excavation during installation and anchor the unit to the concrete slab.
- ◆ Solutions such as sheet piling should be used to secure the sides of the excavation.
- ◆ A retaining wall may be necessary to ensure that the backfill does not move in a difficult installation.

4.4.1 Installation in difficult areas and sites

- ◆ Never use heavy clay soil for the top soil level. If the top soil to be used is predominantly clay then mix it with sand.
- ◆ In all difficult grounds conditions the base of the excavation should be constructed from concrete with a minimum depth of 300 mm.
- ◆ Roots and stones can result in damage to the tank wall and should be removed.
- ◆ The depth to the bottom of the excavation and the concrete base for the Primary Tank must allow an incline of 2% minimum for the wastewater inlet pipe from the property to the Primary Tank.

4.4.2 Installation in difficult ground conditions

- ◆ Once the base of the excavation is stable the installation can begin.
- ◆ Before connecting any pipe work or ventilation pipes ensure the units are perfectly installed and stable on the excavation base. Ensuring that all levels are correct is crucial if the wastewater is to flow efficiently through the system.
- ◆ Pay special attention to the rubber seals. The seals ensure that the system is watertight.

4.4.3 Backfilling in difficult ground conditions

- ◆ In all difficult ground conditions backfilling should be carried out to a level of 20 cm below the tank covers. Concrete should be used, compacted and applied in layers of 300 mm.
- ◆ A retaining wall may be necessary to ensure that the backfill does not move in a difficult installation. The thickness and structure of any retaining wall should be specified by a qualified engineer along with the method of construction and backfilling procedure.
- ◆ At the same time as backfilling around the Primary Tank and BIOROCK® unit both tanks should be gradually filled with clear water (increments of 300 mm)
- ◆ Once the backfilling is finished and compacted, check the levels of the tanks again
- ◆ The various lids or access covers for the system are installed just above ground level to provide easy access for maintenance.
- ◆ Position the hatches and secure them with the screws positioned on the sides.
- ◆ Backfilling to the surface is completed once all pipe work has been connected. With a maximum depth of 20 cm the backfill should consist of top soil without any stones or sharp objects. When building up the final level of backfill around the covers keep in mind any future settlement of the soil.



4.5 INSTALLATION UNDER ROADS, COURTYARDS OR STORAGE AREAS

❖ Installation conditions:

Roads, courtyards or storage areas: The installation will be carried out in accordance with the preceding paragraphs, taking into account the nature of the soil.



For an installation under roads, courtyards or storage areas, a distribution slab of reinforced concrete should be constructed and placed above the tanks

- ◆ The concrete slab must be constructed in such a way that it does not rest on the tanks
- ◆ The edges of the slab must rest on the surrounding ground; the ground must be stable. If unstable ground, specific foundations should be built
- ◆ These foundations, the thickness of the slab distribution, the access to the lids of the tanks, the unit and sampling pipe, the reinforcement and the structure of the slab, etc., will be specified by a qualified civil engineer, based on expected traffic loads and the nature of the soil
- ◆ The high air outlet pipes should preferably be installed outside the concrete slab area, if this is impossible then they should be anchored in the slab.

4.6 OTHER SPECIFIC CASES

4.6.1 Incline too steep (>5%)

A retaining wall may be necessary to ensure that the backfill does not move if the incline is too steep. The thickness and structure of any retaining wall should be specified by a qualified engineer along with the method of construction and backfilling procedure.

Generally, the backfill material must be compacted pea gravel or lean mix concrete applied in layers of 30 cm. (depending on ground conditions)



If you are not sure about the installation, always consult a local engineer



5. VENTILATION & WATER DISTRIBUTION



Never smoke in the vicinity of the installation or sewage works in general.
Never enter the tanks without taking the necessary safety precautions such as ventilation, air monitoring, air supply and other procedures as required.
Always have someone else on site if entering confined spaces.



Both Primary Tank & ECOROCK unit must be vented
The ventilation may be combined, provided that the distance between the air inlet and the air outlet are not too far apart and that the conditions allow it.



The installer is always responsible for a proper ventilation of the Primary Tank & the ECOROCK Treatment Unit



Make sure that the ventilation works properly
Always check the efficiency of the ventilation in both the primary tank and the treatment units with a smoke test



If the site is not suitable for non-electric ventilation, electric ventilation should be installed



Use as few bends as possible
NEVER USE 90° bends
Only use 45° bends

5.1 VENTILATION OF THE PRIMARY TANK

A Primary Tank generates malodorous gases that must be removed by effective ventilation. The Primary Tank must have a ventilation system consisting of a low air inlet and a high air outlet. The distance between the air inlet and air outlet pipe should be as far as possible from each other.

- ◆ The high air outlet pipe should have a wind driven or electrical ventilator
- ◆ The wind driven ventilator must be located at least 400 mm above roof level, clear of all potential obstacles and located at least 1 m away from any windows or skylights
- ◆ We recommend a gradient of 1% to avoid any water settling in the air pipe



- ◆ Only use 45° bends (never use 90° bends)
- ◆ The ventilation pipes must have a minimum diameter of 100 mm
- ◆ The Primary Tank vent pipe must be independent of the properties soil vent pipe
- ◆ The water inlet pipe of the Primary Tank should be plugged or capped (blocked for air)
- ◆ Always check the ventilation with a smoke test in representative conditions (calm weather and storms are not representative conditions)

5.2 VENTILATION OF THE BIOROCK® TREATMENT UNIT

- ◆ The BIOROCK treatment unit has a separate ventilation system
- ◆ The vent pipe for the BIOROCK unit must be independent of the properties soil vent pipe and must not be combined with the Primary Tank vent pipe.
- ◆ The aeration of the both the upper level and the middle section of the treatment unit is combined
- ◆ The air intake is located at the front of the treatment unit
- ◆ The air outlet pipe should always be equipped with a wind driven or electrical ventilator
- ◆ The ventilation pipes must have a minimum diameter of 100 mm
- ◆ Only use 45° bends (never use 90° bends)
- ◆ Always check the ventilation with a smoke test in representative conditions (calm weather and storms are not representative conditions)

If the ventilation is not working properly:

- ◆ Check the ventilation system again by following the diagram
- ◆ Check if the pipe work is obstructed or disconnected at any stage
- ◆ Check if the air outlet pipe is positioned high enough
- ◆ Check that the wind driven ventilator has enough capacity, otherwise change to an electric Ventilator

5.3 WATER DISTRIBUTION PIPE



Make sure the BIOROCK® Media is saturated with clean water

- ◆ Check and adjust the water distribution pipe to ensure an even distribution across the BIOROCK® media
- ◆ Adjust the height/level of the water distribution pipes using the threaded supports
- ◆ The discharge angle can also be adjusted by twisting the pipes
- ◆ Make sure that the BIOROCK® media is completely saturated with water
- ◆ DO NOT completely fill the tanks with water before unit is backfilled
- ◆ DO NOT use dirty or contaminated water
- ◆ Check the connection from the Primary Tank outlet pipe to the BIOROCK® treatment unit
- ◆ There should not be any accumulation of water within the BIOROCK® unit
- ◆ Water should not accumulate on top of the BIOROCK® media
- ◆ The level of the BIOROCK® media must be just under the water distribution pipe
- ◆ Check that the water from the Primary Tank flows by gravity into the BIOROCK® unit



5.4 BIOROCK® MEDIA

BIOROCK® Media is a carrier material for bacteria. The BIOROCK® Media is clearly visible in the tank and the bags overlap each other. Under the water distribution pipe, the BIOROCK® Media will have a grey/black colour.

Don't touch the BIOROCK® Media and don't clean the BIOROCK® if it's not necessary. The top layer of the BIOROCK® Media may be rinsed if blocked or contaminated with solids. In this case we recommend taking out the upper bags, rinsing them (if possible) and placing them back.



For your safety always contact BIOROCK® or your BIOROCK® dealer for replacement or re-arrangement of BIOROCK® media bags.



Used BIOROCK® media can be returned to your dealer or to BIOROCK® S.à.r.l. in Luxemburg for recycling

5.5 SECURING THE LIDS

- ◆ The lids of the BIOROCK® tanks should remain accessible for maintenance
- ◆ Always close and secure the lids after use using a screw driver.

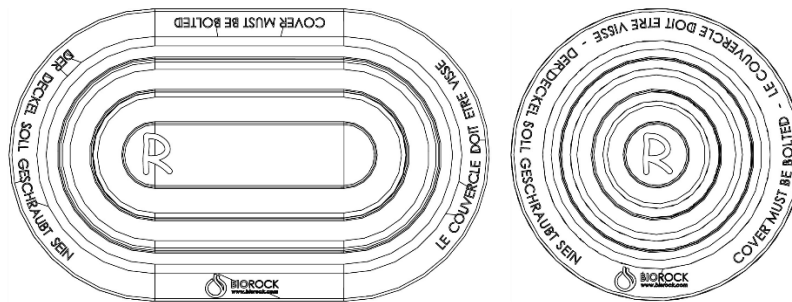

**Always close and secure the lids
Always keep the lids accessible
Make sure the lids are air tight
The lids are for pedestrian use only**



6. STOPPING AND RESTARTING THE SYSTEM

The establishment of an efficient biomass varies. The system start-up period differs depending on the system size, its location, the temperature and especially the conditions of use.

For long periods of shutdown or non-use of the system (absence periods), no special precautions are required. The sewage system will re-start as facilities are used again and will not require any particular attention.

For absence periods exceeding six months, it is recommended to empty the Primary Tank and refill with fresh water.

If the unit is equipped with an electric ventilator, it is best to shut it down during the absence period and to check and clean it before the restart.

If a pump station is installed, it is best to commission it and clean it before the shutdown period.

The BIOROCK® system remains efficient after a shutdown period.

7. CONFORMITY AND WORK COMPLETION

In all cases, the owner and the installer will jointly complete the installation checklist for BIOROCK® Sewage Treatment Plants (Appendix 5) and send it back to the manufacturer at the address listed.

The document is attached to the user's guide. This completed document validates the warranty when received by the manufacturer.

8. RECOMMENDATIONS FOR USE AND MAINTENANCE

See the procedures in Part B of this Manual; User Guide, page 23-47.

9. COMPLIANCE WITH REGULATIONS AND STANDARDS

The ECOROCK-5000 units comply with all requirements of EN 12566-3 + A2, 12566-6 and the Construction Product Regulations.

Performance tests for the CE marking of BIOROCK® units were produced and validated by the European Platform notified as CERTIPRO (notification NB 1476) located in MOL, Belgium.



10. WARRANTY



10 years warranty on the BIOROCK® media *¹

25 years warranty on the BIOROCK® tanks *²

**¹ The 10 years warranty shall only apply if the annual maintenance is carried out by a BIOROCK® approved installer or supervised by a trained BIOROCK® Certified professional*

**² The 25 years warranty shall only apply if the installation is carried out by a BIOROCK® approved installer or supervised by trained BIOROCK® Certified professional*

The equipment and accessories produced at the BIOROCK® factory are guaranteed not to have any manufacturing defects. The equipment and accessories must be transported, stored and handled in such conditions that they are not damaged and do not deteriorate. The ECOROCK-5000 units should never be laid on their side. In case of bad shipment or other damage, the BIOROCK® Media should be removed and replaced correctly as shown in the User Guide.

In the case of incomplete delivery (missing equipment or accessories) or damage observed on delivery, these remarks / observations should be listed on the carriers delivery note or bill. The carrier and the supplier must be informed within 48 hours or 2 business days.

In case of malfunction or construction defect acknowledged by the supplier, the warranty is limited to the replacement of defective parts, excluding all other costs involved. The defective equipment and accessories will be repackaged in their original packaging (if any) and will be made available to the manufacturer.

The warranty will not apply if:

- Failure to correctly size the sewage treatment plant ;
- Failure to follow either the installation requirements or the manufacturers recommendations for the use and maintenance of the primary tank and its pre-filter, as specified in the user's guide (including emptying instructions - constant level);
- Failure to follow either the installation requirements or the manufacturers recommendations for the use and maintenance of the treatment unit, as specified in the user's guide
- Non-compliance with other requirements of regulations and standards in force;
- Damage caused by accidental or climate events beyond our control.

The owner of the treatment unit must complete the installation checklist (Appendix 5: «Warranty», in the User's Guide) to benefit from the "Manufacturers Warranty".

The owner must complete the maintenance book (Appendix 4 in the User's Guide) and keep it up-to-date by adding any maintenance and commissioning activity carried out on the BIOROCK® Sewage Treatment Plant.

Follow the maintenance instructions and visual controls to maintain a reliable and durable system.

Please contact your dealer with any questions.





B. USER GUIDE

FOR THE

BIOROCK SYSTEMS:

ECOROCK-1500

ECOROCK-2000

ECOROCK-3000

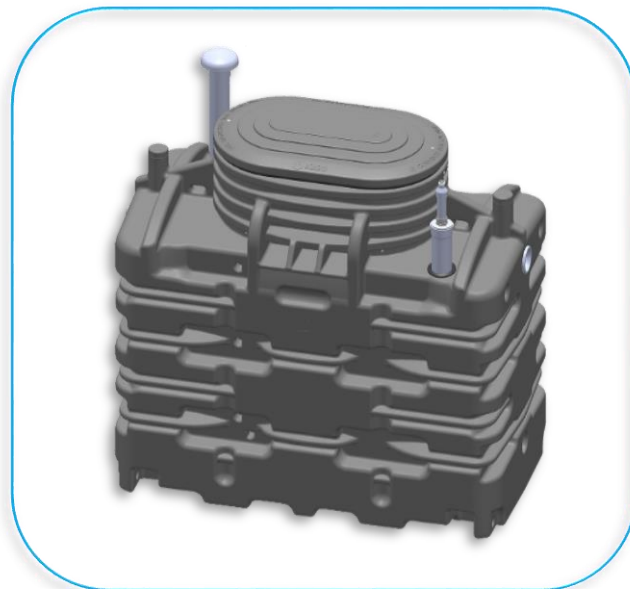

TABLE OF CONTENTS

1. SAFETY INSTRUCTIONS	25
2. SUSTAINABLE DEVELOPMENT	26
2.1 Useful information.....	26
2.1.1. <i>Sustainability</i>	26
2.1.2. <i>Waste disposal</i>	26
2.2 Polyethylene and PVC.....	27
2.2.1. <i>Energy recovery</i>	27
2.2.2. <i>Material recycling</i>	27
2.2.3. <i>The BIOROCK® Media</i>	27
3. OPERATING AND MAINTENANCE INSTRUCTIONS	28
3.1 Primary Tank and Effluent filter	28
3.2 ECOROCK® Treatment Unit.....	31



1. Safety instructions

Related to the installation and operation of a BIOROCK® treatment plant

- ☛ **NOTE:** Consult with certified professionals regarding all installation and maintenance work, and for all operations undertaken on this sewage treatment plant. Your distributor and/or your installer will advise you on how to set up a maintenance contract.
- ☛ **NOTE:** Household wastewater contains human faeces (excrement). This means that wastewater may contain very noxious pathogenic bacteria. Under certain conditions (for instance stagnant wastewater, high temperatures etc.) these noxious pathogenic bacteria may be present in large numbers. Therefore, always use plastic gloves and proper disinfectants if you come into contact with wastewater or with parts which have been in contact with wastewater. The term wastewater also includes the final effluent (the purified wastewater from the BIOROCK® System).
- ☛ **NOTE:** The effluent CANNOT be reused for any other purpose other than discharge into the surface water or infiltration into the soil. The water may contain traces of bacteria, which under certain circumstances (stagnant water, high temperature etc.) may grow in large numbers and be potentially harmful to human health.
- ☛ **NOTE:** The final effluent (the "clean" water from the System) is NOT drinkable.
- ☛ **NOTE:** Always keep the lid closed and open it only for inspections and maintenance work. Never leave the lids and inspection points unsupervised while open. Lids are for pedestrian use only.
- ☛ **NOTE:** Do not put your head directly into the septic tank or BIOROCK® through the manhole even to "have a look" or in an effort to find the cause of a malfunction. Noxious gases may accumulate in the system and may interfere with respiration and cause nausea, dizziness and in very extreme cases loss of consciousness.
- ☛ **NOTE:** Do not install, repair, change or check electrical components yourself; this can be extremely dangerous due to the combination of electricity and water especially when using 230 Volt. Leave this task to a qualified electrician, who can install the system in accordance with NEN 1010. When using 12 Volt electrical accessories, there is no danger of electrocution, but contact a qualified electrician if in doubt.
- ☛ **NOTE:** Never smoke near the work area while the operations described in this manual are being carried out, and never enter the work area without having taken all the prior precautions for ventilation and atmospheric testing as prescribed in the applicable local regulatory provisions.
- ☛ **NOTE:** Any risks during the installation are related to excavation or handling of material. While installing the tanks, use a sling hung from the 4 corners of the upper part of the tank. Make sure that no one is in the maneuvering area, and do not position yourself under the load.



2. SUSTAINABLE DEVELOPMENT

In order to support sustainable development, BIOROCK® has developed a sewage treatment plant with a very low carbon footprint. It does not need electricity, mechanical parts or chemicals to work.

Selecting a product that offers a sustainable solution to the problem of waste disposal is a key factor in protecting the environment. The construction market is becoming increasingly aware of the need for environmentally sustainable solutions to issues such as sewage treatment and the disposal of effluent from off-mains systems. There is a clear shift towards responsible and sustainable products. BIOROCK® sewage treatment systems are the acknowledged leader in this rapidly changing market.

All materials used in the manufacture and assembly of the BIOROCK® systems equipment are corrosion-resistant to ensure a long term installation. The main components are polyethylene (Tanks), PVC (piping) and the BIOROCK® media. Nearly 100% of the components can be recycled.

2.1 USEFUL INFORMATION

2.1.1 Sustainability

Sustainable development is based on three factors: Protection of the environment, social progress, and economic development.

Both production methods and consumption must respect both human beings and the natural environment to enable all inhabitants on Earth to meet their basic needs (food, clothing, education, work, living in a healthy environment).

Education for sustainable development is fundamental: it is the main necessary step towards a general change in mindset and behavior. This change in mindset for each of us (citizens, businesses, local authorities, governments, international institutions) is necessary to address threats to the Earth (social inequality, industrial and health risks, climate change, biodiversity loss, etc.).

2.1.2 Waste disposal

Waste results from the operation of treatment systems and maintenance of drainage systems for sewage and rainwater. These are predominantly organic waste (sludge, grease, wastewater treatment plant waste, drain material, etc.) or mineral (sand treatment plant, sludge, sewage sands, etc.).

Sludge produced in the Primary Tank must be removed by a licensed contractor.

The used BIOROCK® media can be returned to BIOROCK® for recycling.

The effluent filter for the Primary Tank can be disposed after rinsing.



2.2 POLYETHYLENE AND PVC

PE and PVC are recoverable using different processes

2.2.1 Energy recovery

Incineration leads to energy recovery. However it may generate pollutants and gas.

2.2.2 Material recycling

Recycling plastics of this nature (PVC, PE) into granules or powder which can be sold as an alternative to virgin material in manufacturing.

2.2.3 The BIOROCK® media

The BIOROCK® media is inert but if there is a need to replace some of the media the dirty bags (once removed) must be cleaned before recycling.

The used BIOROCK® Media can be returned to the BIOROCK® Head Office for recycling.

Always use a professional waste disposal contractor to periodically remove sludge. Once removed, the sludge will be disposed safely at an approved facility.



3. OPERATING & MAINTENANCE RECOMMENDATIONS

If you have not subscribed to a service and maintenance contract, consult a BIOROCK® Certified or a BIOROCK® trained and approved company for the maintenance on your sewage treatment plant.

Contact your dealer if necessary or contact us for more details about the closest dealer to you.

The summary below indicates the commissioning of your sewage treatment plant.

Your sewage treatment plant can be free from any failures as the BIOROCK® system does not require electricity. (In normal operation, and following the maintenance recommendations)

GENERALLY:

Every year:

- ✓ Visually check the water tightness of the complete system
- ✓ Check the ventilation
- ✓ Check if there are any smells exiting the tanks

PRIMARY TANK

Every year:

- ✓ Check the sludge level
- ✓ Empty the Primary Tank if the sludge level is > 50%
- ✓ Change the effluent filter if necessary or change after emptying the Primary Tank
- ✓ Take a sample of the effluent from the Primary Tank and check quality visually

ECOROCK UNIT

Every year:

- ✓ Clean the water distribution pipe
- ✓ Check and re-adjust the water distribution pipe if necessary
- ✓ Check the first layer of BIOROCK® Media
- ✓ Rinse or replace the first layer of BIOROCK® Media if necessary
- ✓ Remove and clean the alarm
- ✓ Take a sample of the outgoing water (final effluent) and check for clearness and odour. Clearness means that the water contains few suspended particles. The colour may vary from neutral to dark yellow. The odour of the water will normally be neutral to light ammonia.

Neutral



Dark yellow



3.1 PRIMARY TANK AND EFFLUENT FILTER

For a non-BIOROCK Primary Tank please refer to the maintenance schedule from the manufacturer of the Primary Tank that you have purchased. However, should you be unable to get information, BIOROCK can provide a maintenance planning schedule giving you an overview of the maintenance procedures.

Please check how often you need to empty your Primary Tank in line with local regulations. Please check if the Primary Tank has the required efficiency that is required by BIOROCK. See page 9, Chapter 2.1.

MAINTENANCE GUIDE FOR THE PRIMARY TANK (PT) AND THE EFFLUENT FILTER (EF)

Sampling of the pre-treated waste water coming from the Primary Tank

Take your first sample 6 months after commissioning, then once a year, or at the same time as the Primary Tank is emptied

- ◆ Check (visually) the pre-treated wastewater quality
- ◆ Take a sample (with rubber or latex domestic use gloves) of the purified sewage water in a clean glass.
- ◆ The color of the water should range from light brown to yellow, from turbid to very turbid, but very little deposit should show at the bottom of the sample after it has rested for twenty minutes
- ◆ The purified water may have a slight (septic) odor



If the water looks different or you find increased deposits in the pre-treated waste water, this may be caused by:

- ◆ Water flowing too fast through the PT, too short retention time (hydraulic overload). Check that no rainwater run-off system passes through the installation.
- ◆ The volume of the Primary Tank is too small to accommodate normal usage
- ◆ Incorrect disposal of harmful, toxic, anti-bacterial or non-biodegradable products into the installation
- ◆ You may need to call a certified septic tank cleaning company to empty the PT and to clean it (skimming off the fats and floating matter — the surface layer). Never completely empty the PT; always leave a layer of sludge at the bottom to ensure that it continues to function correctly after it has been emptied
- ◆ In all of these cases, you should consult the documents and user manuals provided by the tank manufacturer



If you notice any foul odors, these may be caused by:

- ◆ The ventilation system is not working properly
- ◆ The ventilation system is not airtight at the T-piece of the water inlet in the PT
- ◆ The internal waste water system in the house is not vented properly with a soil vent pipe
- ◆ The inspection seals or the seals on the Primary Tank are not air- or watertight
- ◆ Insufficient airflow through the ventilation system; ventilation pipes too small - diameter >100 mm, a badly positioned wind driven ventilator, etc.
- ◆ A block in the airflow in the tank itself, because the surface layer has become too thick (for example fats & floating matter) or a baffle wall that is too high.
- ◆ In all of these cases, you should consult the documents and user manuals provided by the manufacturer.



Effluent Filter cleaning and replacement

The BIOROCK® effluent filter does not need to be cleaned.

We advise you to replace it when the Primary tank is emptied, or when the filter is clogged, or after two years.

- ◆ Open the cover at the PVC pipe that provides access to the Effluent Filter
- ◆ Take the rod holding the Effluent Filter and lift it carefully to remove
- ◆ Beware of flying particles

Emptying of the Primary Tank

The first emptying of the Primary Tank takes place, when the sludge level reaches 50% of the Primary Tank volume, unless superseded by local regulations.

- ◆ Always use a certified septic tank emptier.
- ◆ Replace the Effluent Filter at least every two years.
- ◆ The frequency with which the tank is emptied may be adapted according to the nature of the operation and how many people live in the building. It must be emptied when the sludge level reaches 50%.
- ◆ The cleaning certificate, written by the certified septic tank cleaning company, must be retained by the owner in and placed in the maintenance guide.
- ◆ The septic tank emptier should pressure wash the sides of the tank and the Effluent Filter to remove the accumulated fats and other matter.
- ◆ The tanker, while emptying the Primary Tank, must not be parked any nearer than 4 meters (14') from the installation to ensure and maintain stability.
- ◆ Refill the Primary Tank with clean water after emptying before resuming normal operation.

Further information:

The quantity of sludge produced is influenced by how the unit is used (size, frequent overloads, type of waste water, routine maintenance). Each unit is different.

ECOROCK-1500	Sludge production in Primary Tank		
	ECOROCK-1500 6 PE	ECOROCK-2000 10 PE	ECOROCK-3000 15 PE
Capacity in Person Equivalent			
Sludge production	1.100 Liters/year	1.825 Liters/year	2.700 Liters/year

We estimate that an installation of 5 PE will produce a maximum of +/- 900 liters of sludge in the first year. The quantity of sludge produced will reduce over the first few years: normally after the fourth or fifth year, the residual quantities will have decreased by 40%. When emptying, the cleaner must leave a few centimeters of sludge at the bottom of the tank; the bacteria that break down the sludge are specific and take a long time to develop.



3.2 THE ECOROCK® TREATMENT UNIT

The 10 years warranty shall only apply if the annual maintenance is carried out by a BIOROCK® approved installer or supervised by a trained BIOROCK® Certified professional

MAINTENANCE PLANNING FOR THE ECOROCK-5000 SEWAGE TREATMENT PLANT



**Only take a sample from running water.
Never use a sample from stagnant water**

Effluent sampling:

6 months after start-up, then every year

- ◆ Only take a sample from running water. Never use a sample from stagnant water
- ◆ Take a sample of the outgoing water (final effluent) and check for clearness and odour. Clearness means that the water contains few suspended particles. The colour may vary from neutral to dark yellow. The odour of the water will normally be neutral to light ammonia
- ◆ Sampling can be done via any sampling point or directly at the outlet of the tank
- ◆ Always wear rubber or latex domestic gloves when taking a sample
- ◆ The outgoing water should be clear. A little deposit might show at the bottom of the sampling glass after it has rested for twenty minutes
- ◆ The water shouldn't have a septic or nauseating odor. It may have the characteristic smell of fresh humus
- ◆ If the visual check seems to show a malfunction (turbid treated water, presence of deposits or suspended matter, nauseating or septic odor), take the sample to a certified laboratory for testing
- ◆ If the laboratory confirms a problem with the water quality check:
 - if the primary tank is functioning properly
 - the quality of the pre-treated water from the Primary Tank
 - if there are any fats or solids on the surface of the BIOROCK® Media
 - the water distribution in the BIOROCK® unit
 - if the ventilation of the Primary Tank is functioning properly
 - if the ventilation of the BIOROCK® system is functioning properly
 - if the unit is correctly sized for its required capacity
 - the presence of harmful, toxic, antibacterial or non-biodegradable products in the installation



If you notice the presence of increased deposits (suspended matter) in the treated waste water or if the unit is clogged up:

A prolonged overload of pollution in the installation, repeated misuse of the primary tank (late sludge removal, an inefficient effluent filter and neglect over several years) can lead to the saturation of the BIOROCK® Media in the bioreactor.



Cleaning or replacement procedure for the BIOROCK® Media:

You can remove the bags of BIOROCK® Media, using a metal hook or a rake.
 After use the BIOROCK® media can be returned to BIOROCK® Head Office for recycling.

- ◆ If the BIOROCK Media is clogged, remove the bags of BIOROCK® media until you arrive at the clean bags
- ◆ If possible clean the BIOROCK® media with a normal water hose. Wash the bags in a basin of water, agitating them aggressively, so that all of the sludge that has accumulated in the bags is removed
- ◆ If it is impossible to clean the BIOROCK® media, replace with new bags
- ◆ Before returning the BIOROCK® media bags, clean the inside of the tank and if necessary the Aeration rings
- ◆ Carefully place the bags back in the unit as detailed below

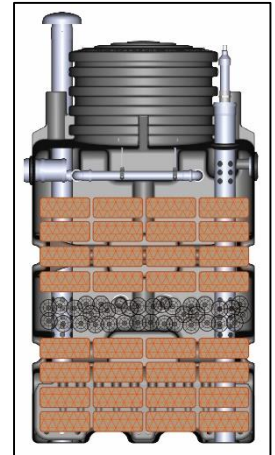

Build-up of the BIOROCK® media from bottom to top:

Layers 1 to 4	Layer 5	Layer 6	Layers 7 to 9
BIOROCK® media 20x20x20 mm	plastic aeration rings	BIOROCK® media 10x10x10 mm	BIOROCK® media 20x20x20 mm

While replacing the bags of BIOROCK® Media, make sure that each layer of bags completely covers the surface of the unit, ensure that there is no free space between the bags. The bags of BIOROCK® Media should always overlap each other. Ensure that the aeration rings are put back to the same position and height. Above the aeration rings, the BIOROCK® media with the dimension of 10x10x10 mm is laid.



A well performing BIOROCK® unit does not produce a bad smell, it should have a smell of fresh humus
Problems with bad smells are generally caused by a poor ventilation

Check the alarm

To be done annually

Clean the float and the pipe with clean water.
 Visually check the alarm positioning: ⇒ Lift lightly and let it go down.



Check water tightness of the water inlet pipe and the water distribution pipe*To be done annually*

Visually check the water tightness of the water inlet pipe from the Primary Tank.

**Check that the water distribution pipe provides an equal distribution of water to the BIOROCK® media***To be done annually*

Clean the inside of the water distribution pipe with clean water. Preferably above an open PT.

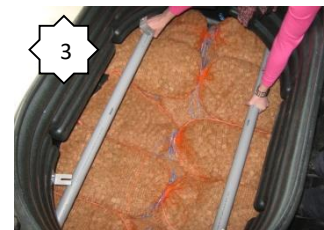
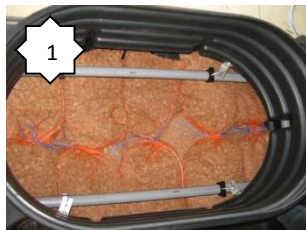

1. Unclip the water distribution pipe and remove the pipe system from the tank
2. Adjust the height/level of the water distribution pipes using the threaded supports
3. The discharge angle can also be adjusted by twisting the pipes

Checking the flow and the BIOROCK® media*To be done annually*

If an inspection shows an increasing amount of suspended solids in the outgoing water (final effluent), or an accumulation of suspended solids at the top layer of BIOROCK® media, then the BIOROCK® media may need to be cleaned more thoroughly.

For this, please contact your supplier or maintenance service provider.



Any long-lasting water accumulation on the surface of the bags indicates that it is necessary to clean at least the first layer of BIOROCK® media.

Remove as many layers of BIOROCK® media as necessary. If possible, wash the bags, if not change as many BIOROCK® media bags as necessary.

Carefully place the bags back in the unit. Make sure that each layer of bags completely covers the surface of the unit, that there is no free space between the bags and that the bags overlap each other.

The frequency of cleaning and / or replacement of the BIOROCK® media bags depends on the quantity and quality of effluent leaving the Primary Tank.

**If you still notice the presence of fats:**

If flow difficulties persist after the above cleaning operations, check for an accumulation of fat upstream from the BIOROCK® treatment unit.

In this case, the Primary Tank and the Effluent Filter efficiency must be checked.



C. APPENDICES

Appendix 1: Technical drawings of the various components

1.1 Drawing of an ECOROCK-1500 treatment unit (6PE)	35
1.2 Aeration & Water distribution schematic of an ECOROCK-1500 (6PE)	36
1.3 Cross section of the layers of BIOROCK® Media in an ECOROCK-1500 unit	37
1.4 Drawing of an ECOROCK-1500 treatment unit (8PE)	38
1.5 Aeration & Water distribution schematic of an ECOROCK-1500 (8PE)	38
1.6 Drawing of an ECOROCK-2000 treatment unit	40
1.7 Aeration & Water distribution schematic of an ECOROCK-2000	41
1.8 Cross section of the layers of BIOROCK® Media in an ECOROCK-2000 unit	42
1.9 Drawing of an ECOROCK-3000 treatment Unit	43
1.10 Aeration & Water distribution schematic of an ECOROCK-3000	44
1.11 Cross section of the layers of BIOROCK® Media in an ECOROCK-3000 unit	45

Appendix 2: Installation drawings of the ECOROCK® installations

2.1 Drawing (Cross section) of 1x ECOROCK-1500 plant in dry ground conditions (6PE) ..	46
2.2 Drawing (Cross section) of 1x ECOROCK-1500 in high ground water conditions (6PE)	46
2.3 Drawing (Cross section) of 1x ECOROCK-1500 plant in dry ground conditions (8PE)...	47
2.4 Drawing (Cross section) of 1x ECOROCK-1500 in high ground water conditions (8PE)	47
2.5 Drawing (Cross section) of 1x ECOROCK-2000 plant in dry ground conditions	48
2.6 Drawing (Cross section) of 1x ECOROCK-2000 in high ground water conditions	48
2.7 Drawing (Cross section) of 1x ECOROCK-3000 plant in dry ground conditions	49
2.8 Drawing (Cross section) of 1x ECOROCK-3000 in high ground water conditions	49

Appendix 4:

REGISTRATION FORM FOR YOUR BIOROCK® PLANT	50
---	----

Appendix 5:

WARRANTY	51
----------------	----



APPENDIX 1

1.1

Drawing of an ECOROCK-1500 treatment unit

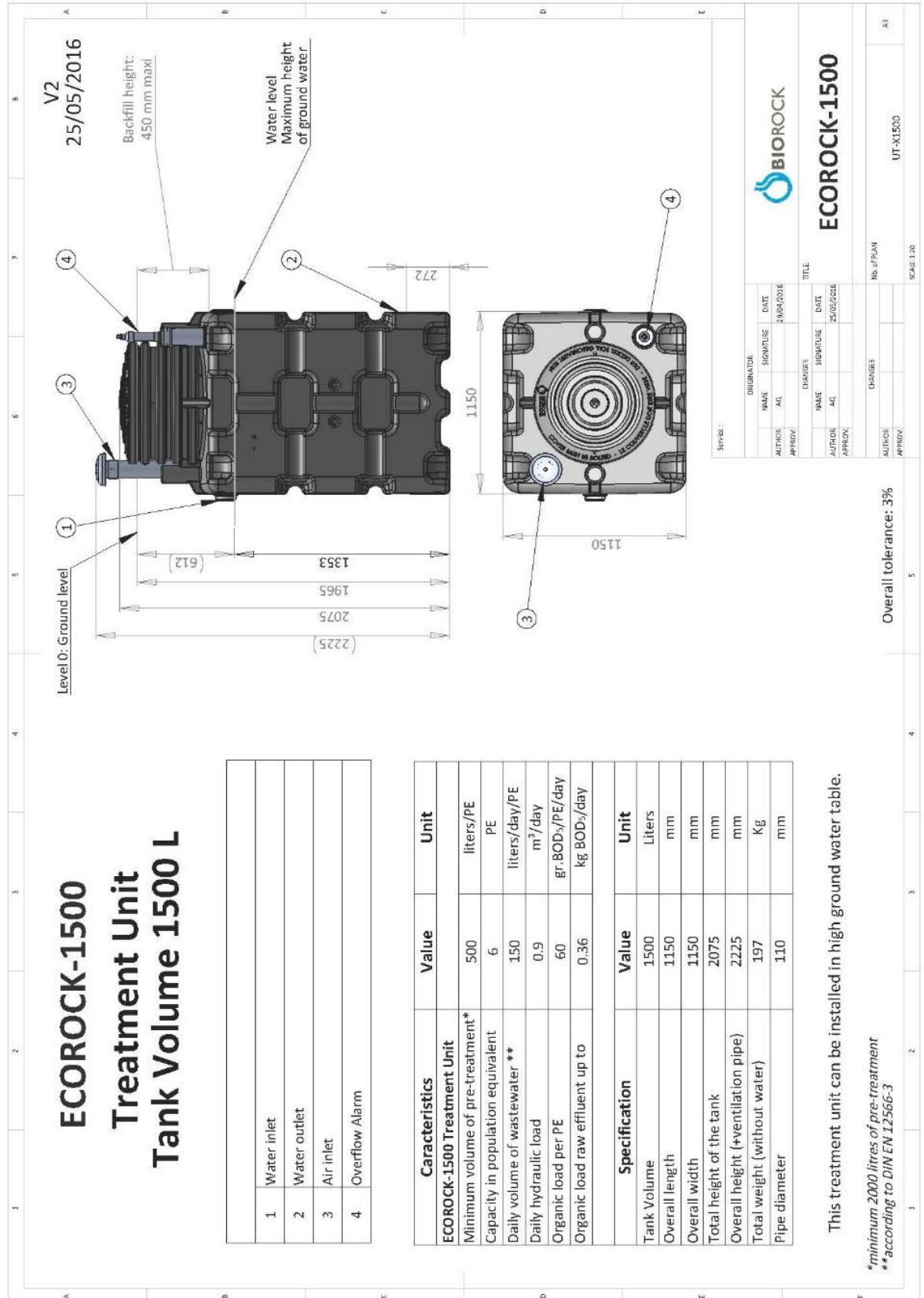

APPENDIX 1

1.2

Aeration and water distribution scheme (without pumping well)

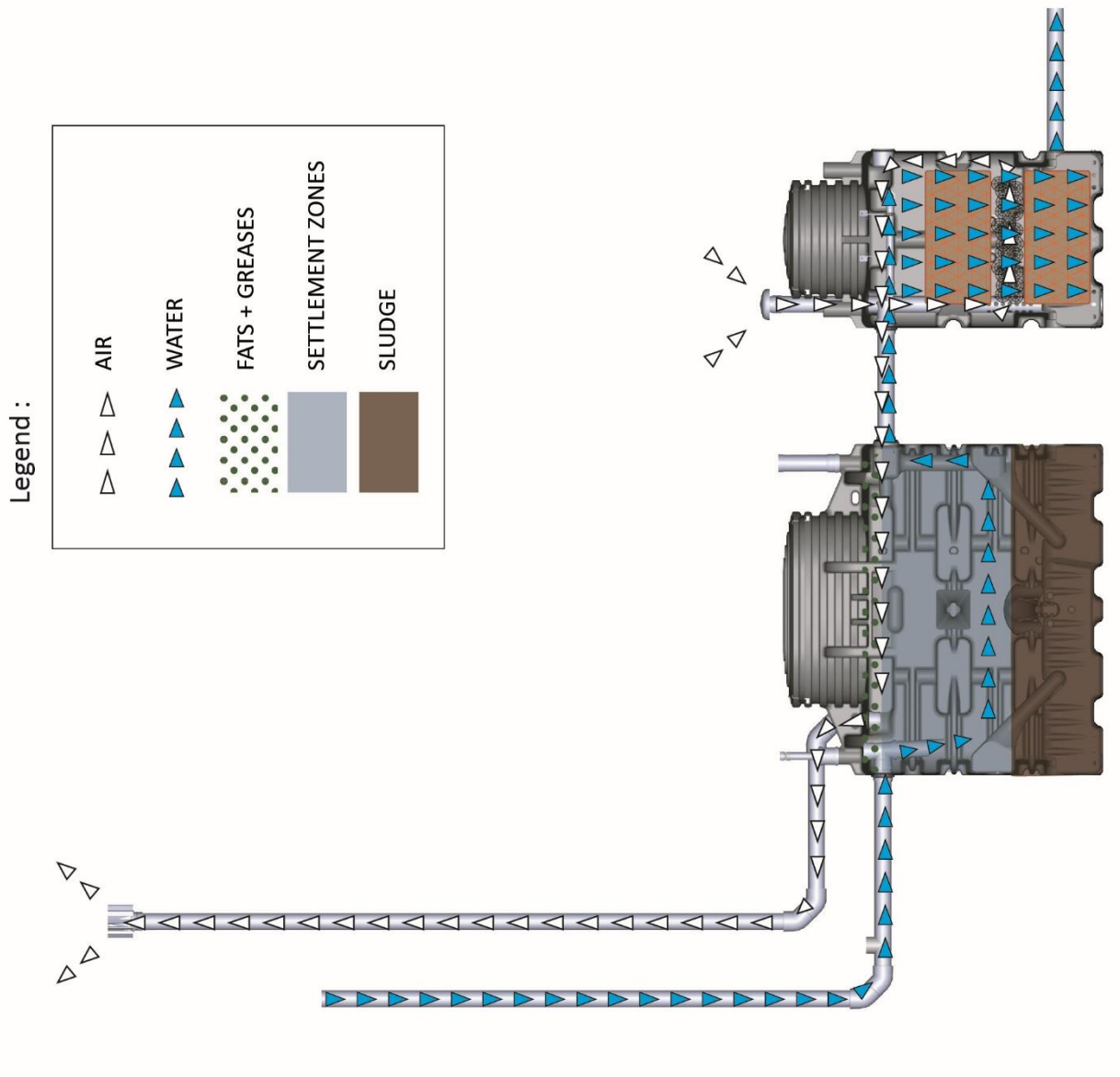

APPENDIX 1

1.3

Drawing (Cross section) showing the layers of BIOROCK® Media in a ECOROCK-1500 unit

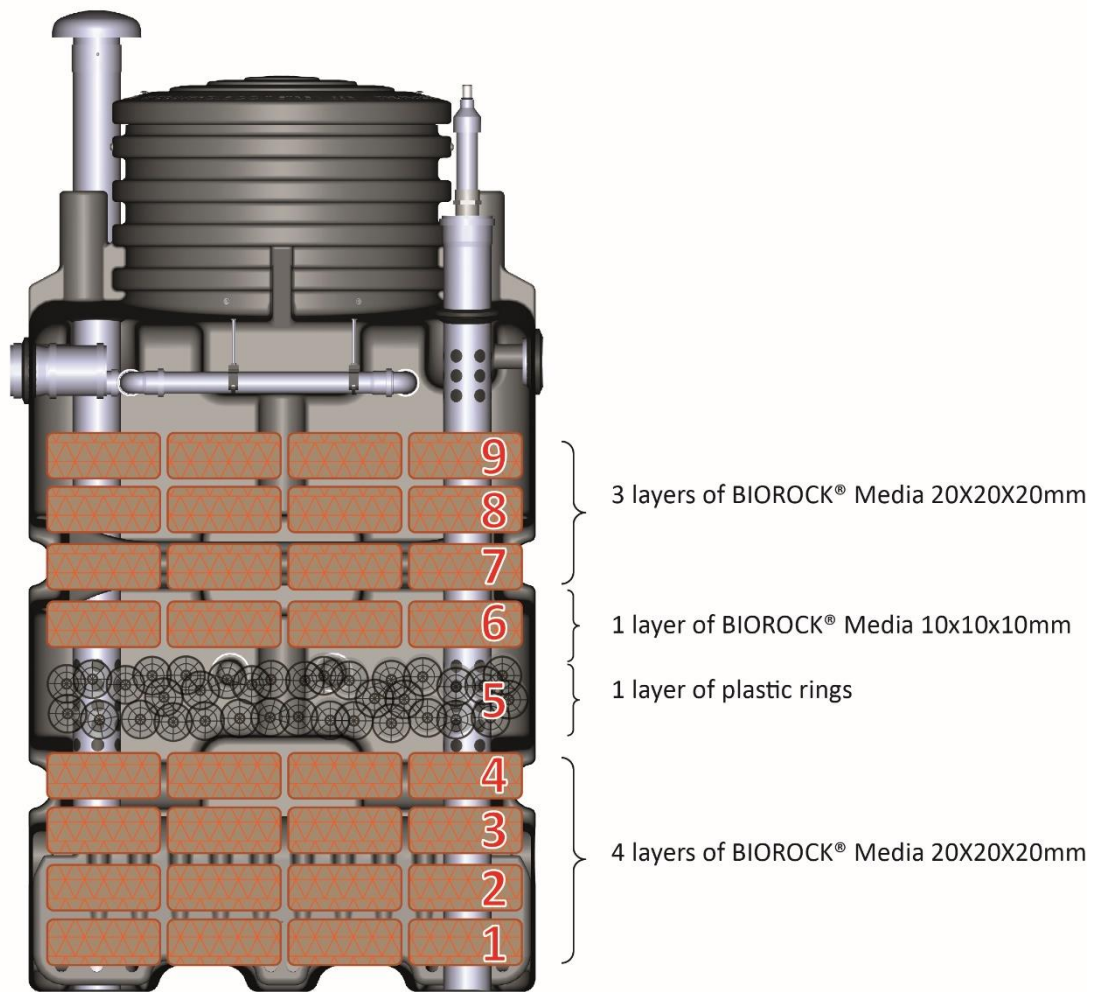

APPENDIX 1

1.4

Drawing of an ECOROCK-1500 treatment unit

ECOROCK-1500 Treatment Unit Tank Volume 1500 L

1	Water inlet
2	Water outlet
3	Air inlet
4	Overflow Alarm

Characteristics	Value	Unit
ECOROCK-1500 Treatment Unit		
Minimum volume of pre-treatment	5000	liters
Capacity in population equivalent	8	PE
Daily volume of wastewater **	150	liters/day/PE
Daily hydraulic load	1.2	m ³ /day
Organic load per PE	60	gr.BOD ₅ /PE/day
Organic load raw effluent up to	0.48	kg BOD ₅ /day

Specification	Value	Unit
Tank Volume	1500	Liters
Overall length	1150	mm
Overall width	1150	mm
Total height of the tank	2075	mm
Overall height (+ventilation pipe)	2225	mm
Total weight (without water)	197	Kg
Pipe diameter	110	mm

V2
25/05/2016

Backfill height:
450 mm maxi

Water level
Maximum height
of ground water

Level 0: Ground level

(2225)
2075
1965
1353
(612)

272

1150

1150

3

4

4

2

1

BIOROCK

ECOROCK-1500

TITLE

ORIGINATOR	NAME	SIGNATURE	DATE
AUTHOR	AQ		25/05/2016
APPROV			
CHANGES	NAME	SIGNATURE	DATE
AUTHOR	AQ		25/05/2016
APPROV			
CHANGES	AUTHOR	APPROV	Nb. of PLAN
			UT-XI.1500
			SCALE 1:20

Overall tolerance: 3%

**according to DIN EN 12566-3

This treatment unit can be installed in high ground water table.



APPENDIX 1

1.5

Aeration and water distribution scheme (without pumping well)

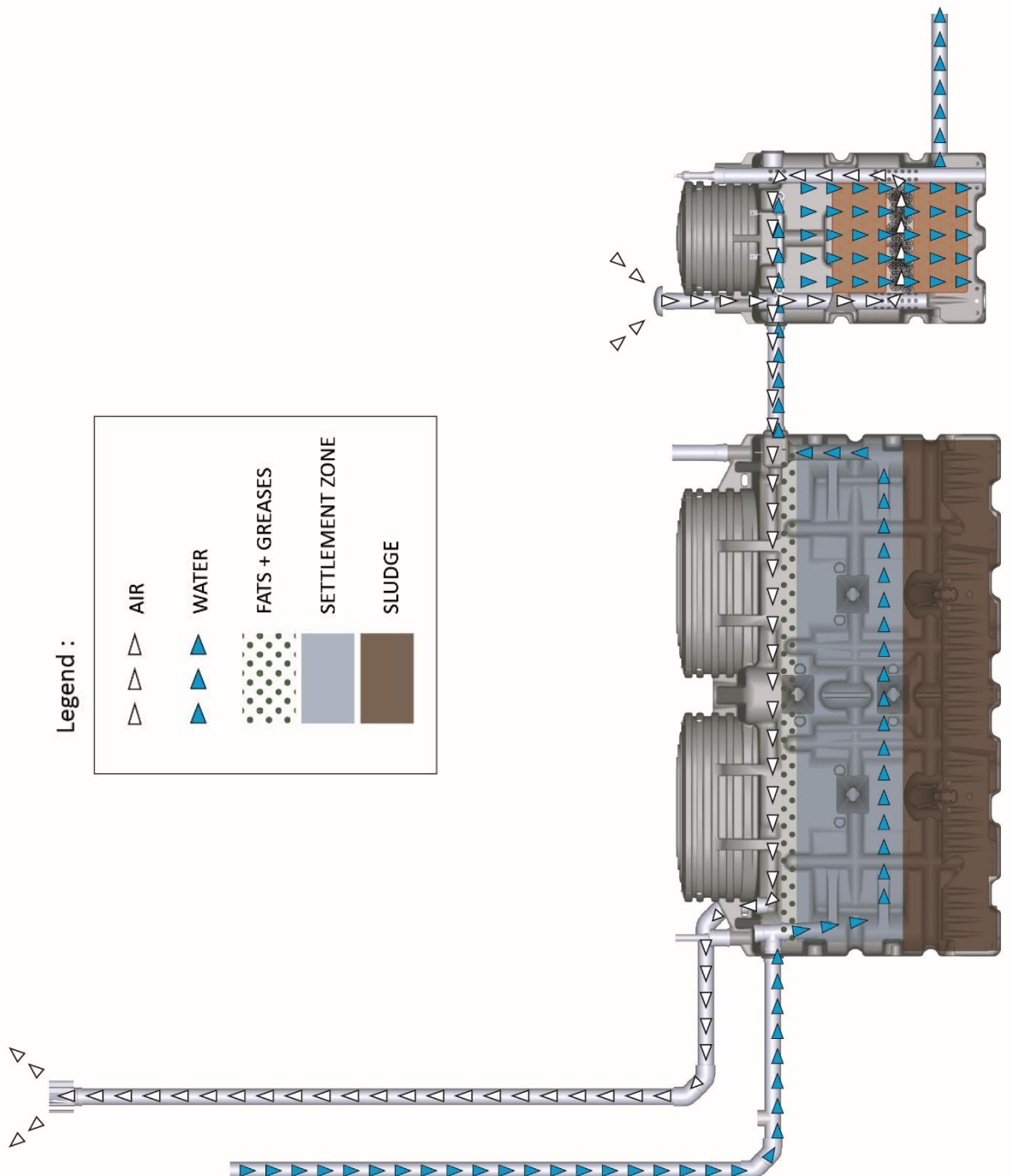

APPENDIX 1

1.6

Drawing of an ECOROCK-2000 treatment unit



**ECOROCK-2000
Treatment Unit
Tank Volume 2000 L**

1	Water Inlet
2	Water outlet
3	Air Inlet
4	Overflow Alarm

Characteristics	Value	Unit
ECOROCK-2000 Treatment Unit		
Minimum volume of pre-treatment*	500	liters/PE
Capacity in population equivalent	10	PE
Daily volume of wastewater**	150	liters/day/PE
Daily hydraulic load	1.5	m ³ /day
Organic load per PE	60	gr.BOD ₅ /PE/day
Organic load raw effluent up to	0.6	kg BOD ₅ /day

Specification	Value	Unit
Tank Volume	2000	Liters
Overall length	1450	mm
Overall width	1150	mm
Total height of the tank	2075	mm
Overall height (+ventilation pipe)	2225	mm
Total weight (without water)	241	Kg
Pipe diameter	110	mm

This treatment unit can be installed in high ground water table.

*minimum 2000 liters of pre-treatment

**according to DIN EN 12566-3

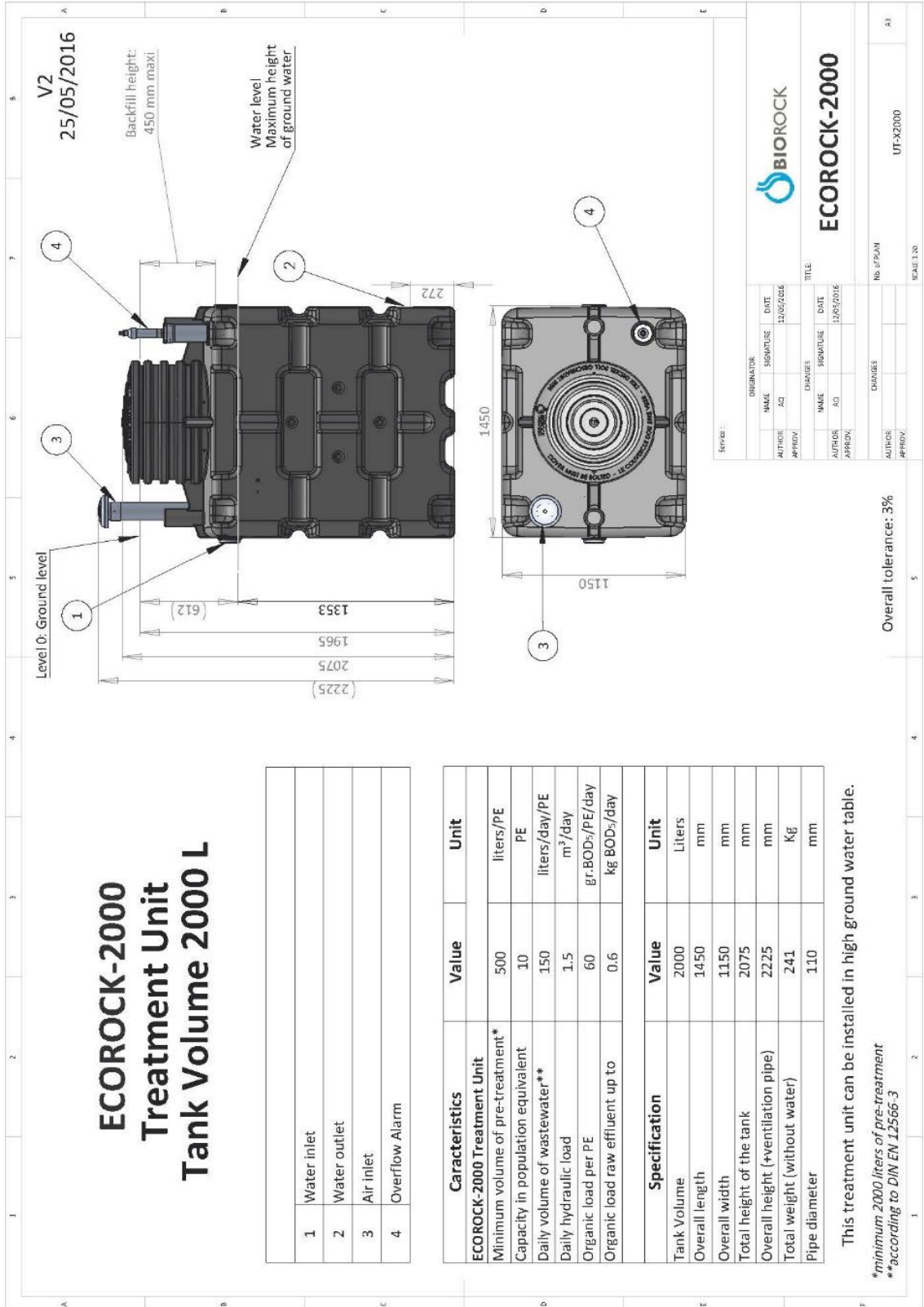

DESIGNATION		DATE
NAME	SIGNATURE	12/02/2016
AUTHOR	AD	
APPROV.		
CHANGES		TITLE
NAME	SIGNATURE	DATE
AUTHOR	AD	12/05/2016
APPROV.		
CHANGES		No. / PLAN
AUTHOR		UT-X2000
APPROV.		A3

BIOROCK
ECOROCK-2000
SCALE 1:20

Overall tolerance: 3%

APPENDIX 1
1.7

Aeration and water distribution scheme (without pumping well)

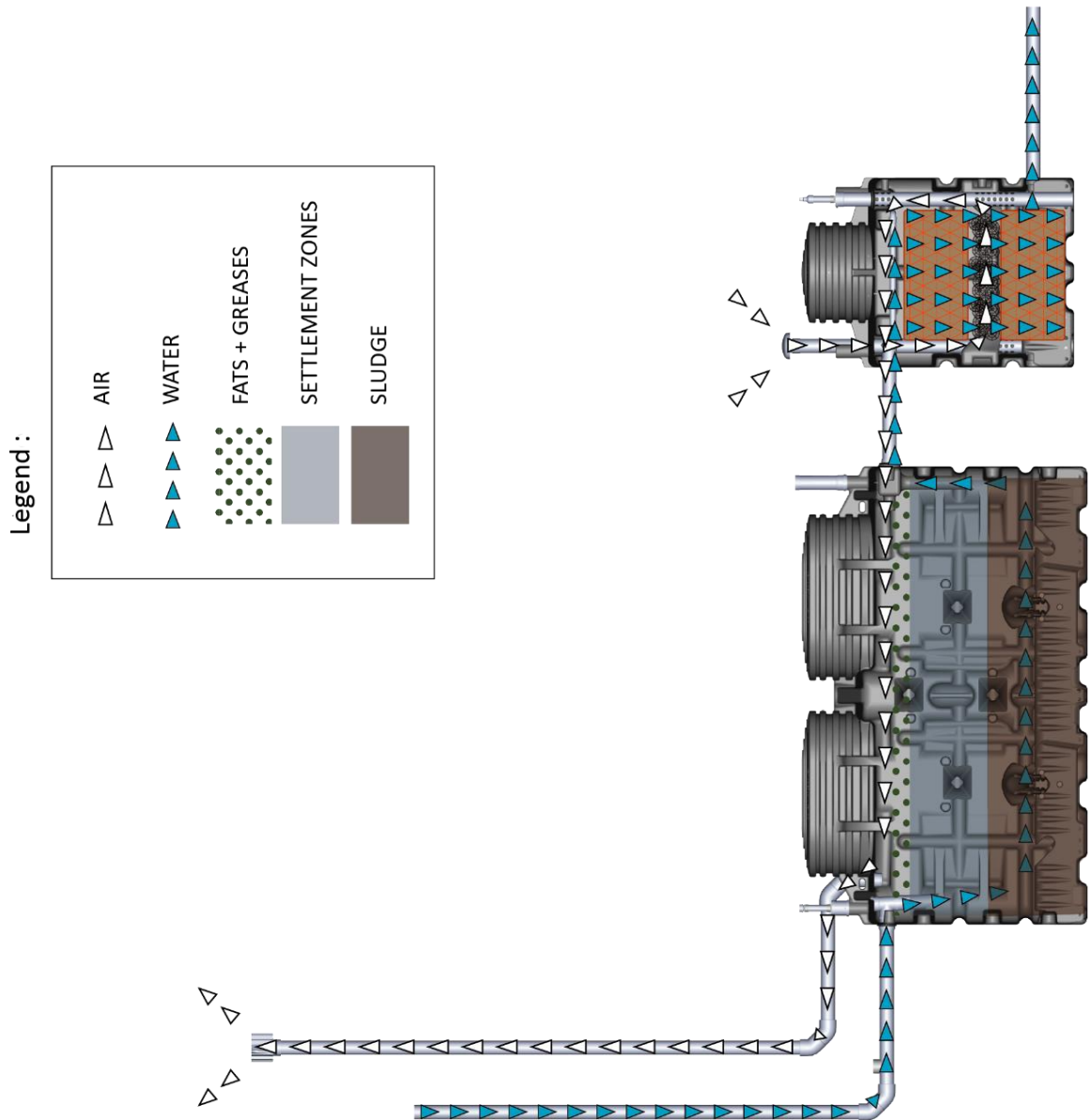

APPENDIX 1

1.8

Drawing (Cross section) showing the layers of BIOROCK® Media in a ECOROCK-2000 unit

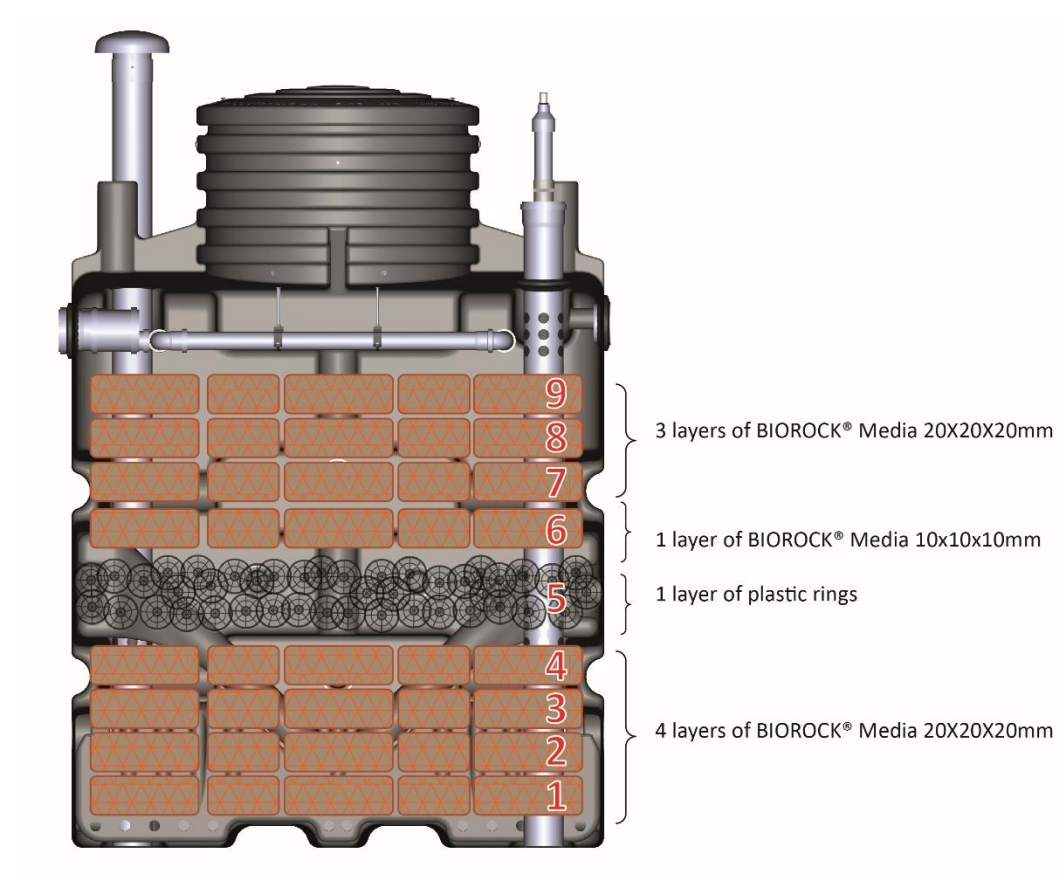

APPENDIX 1

1.9

Drawing of an ECOROCK-3000 treatment unit

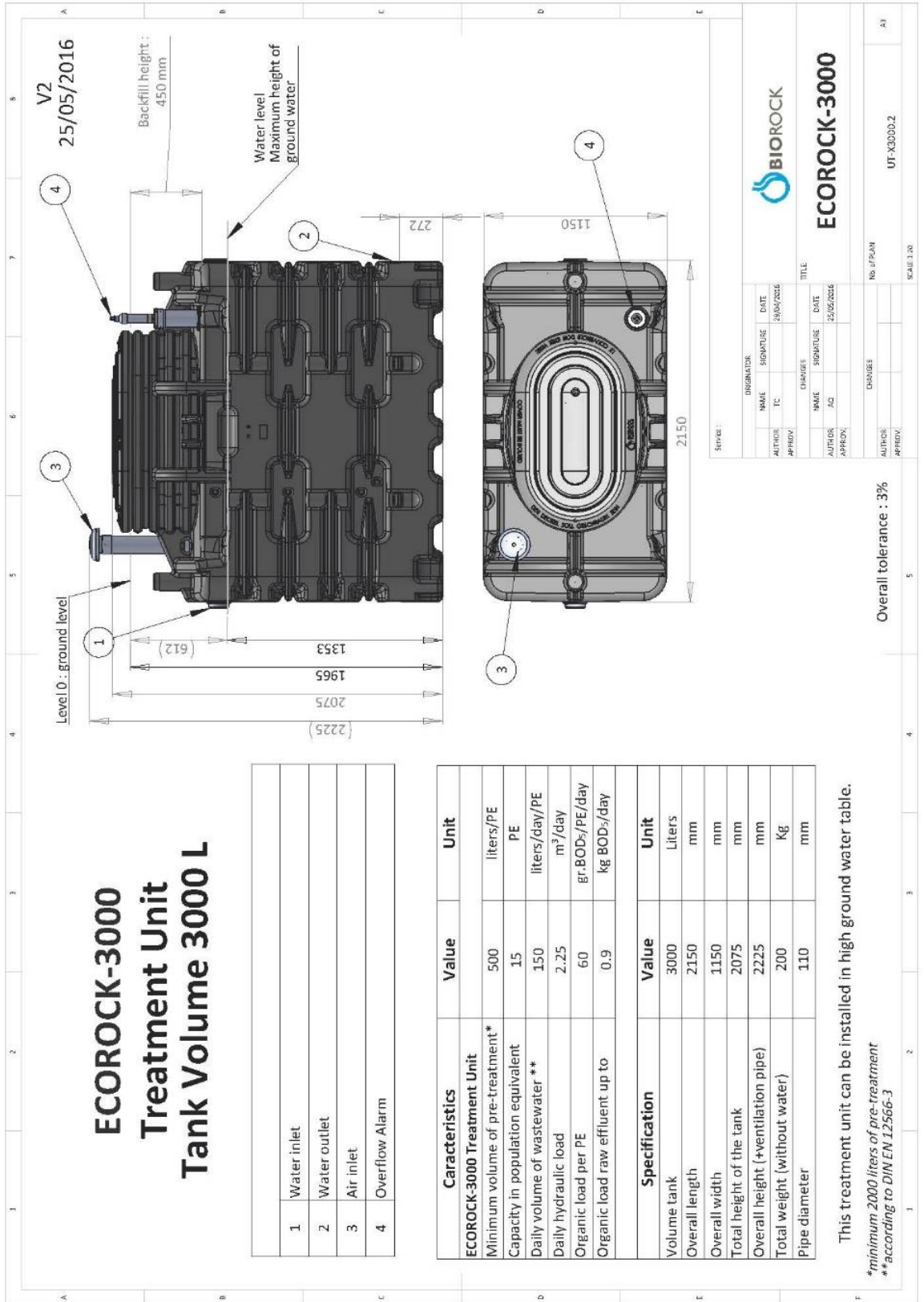

APPENDIX 1

1.10

Aeration and water distribution scheme (without pumping well)

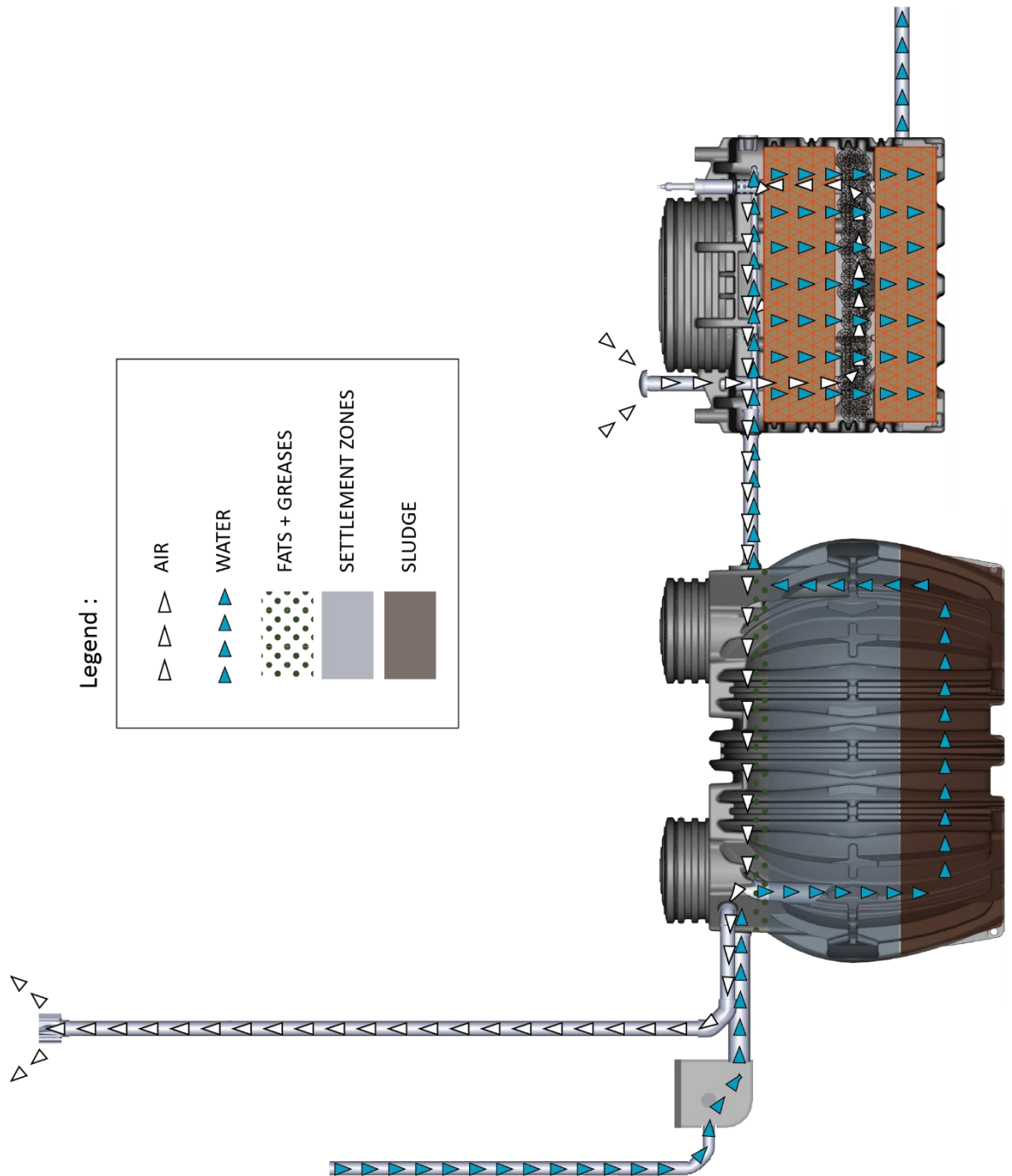

APPENDIX 1

1.11

Drawing (Cross section) showing the layers of BIOROCK® Media in a ECOROCK-3000 unit

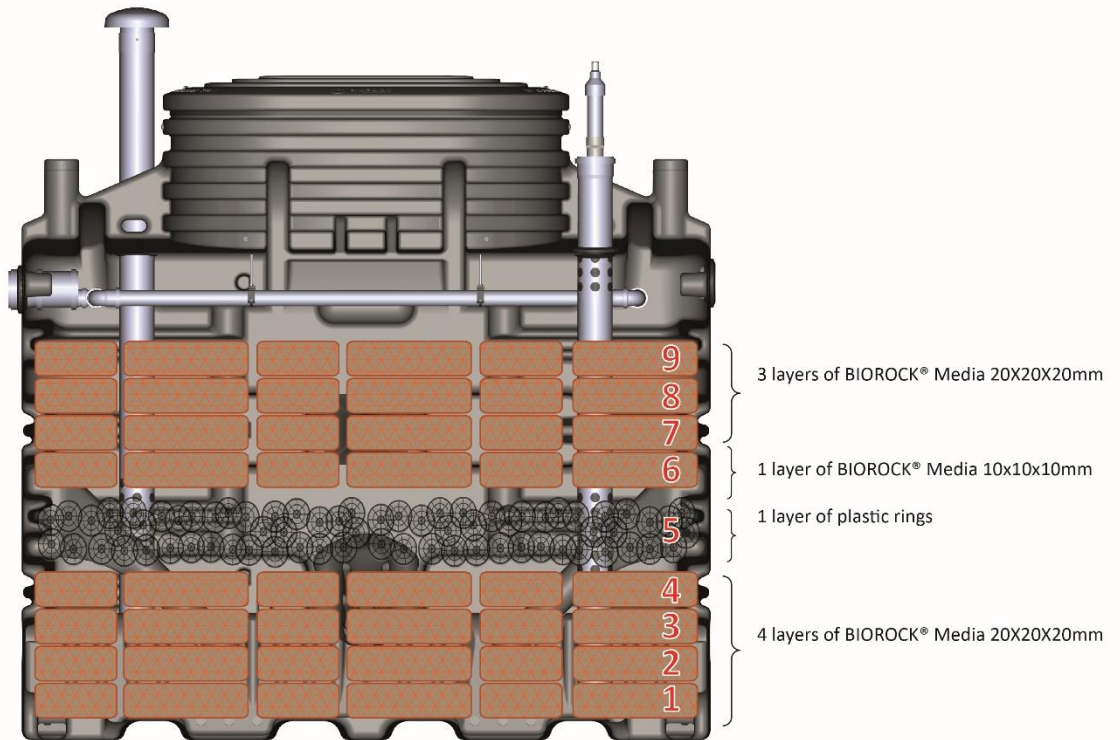

APPENDIX 1

2.1

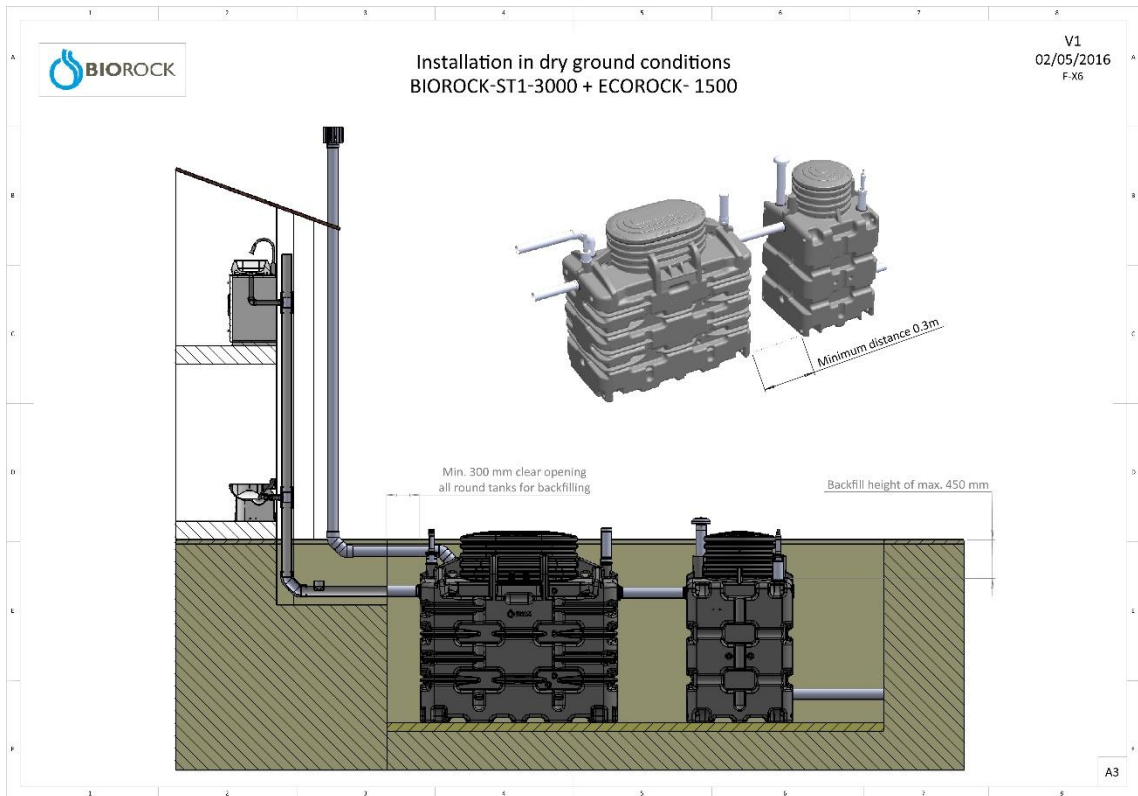

APPENDIX 2

2.2

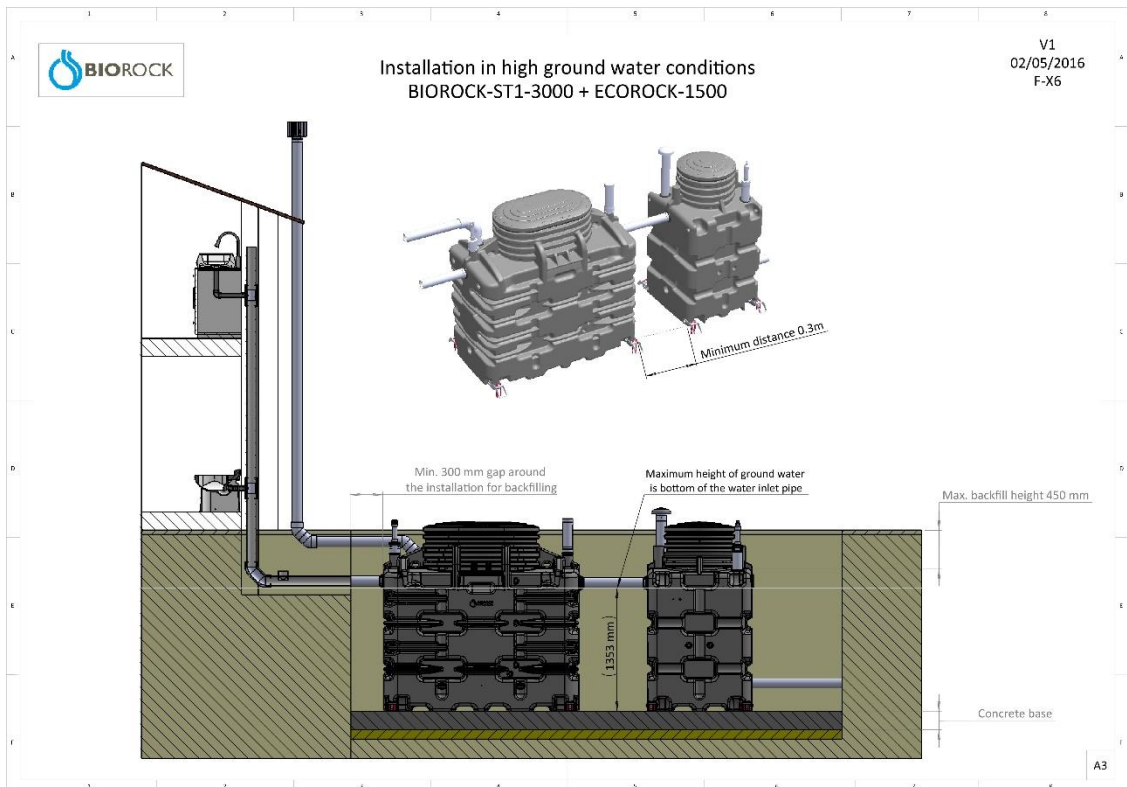

APPENDIX 2

2.3

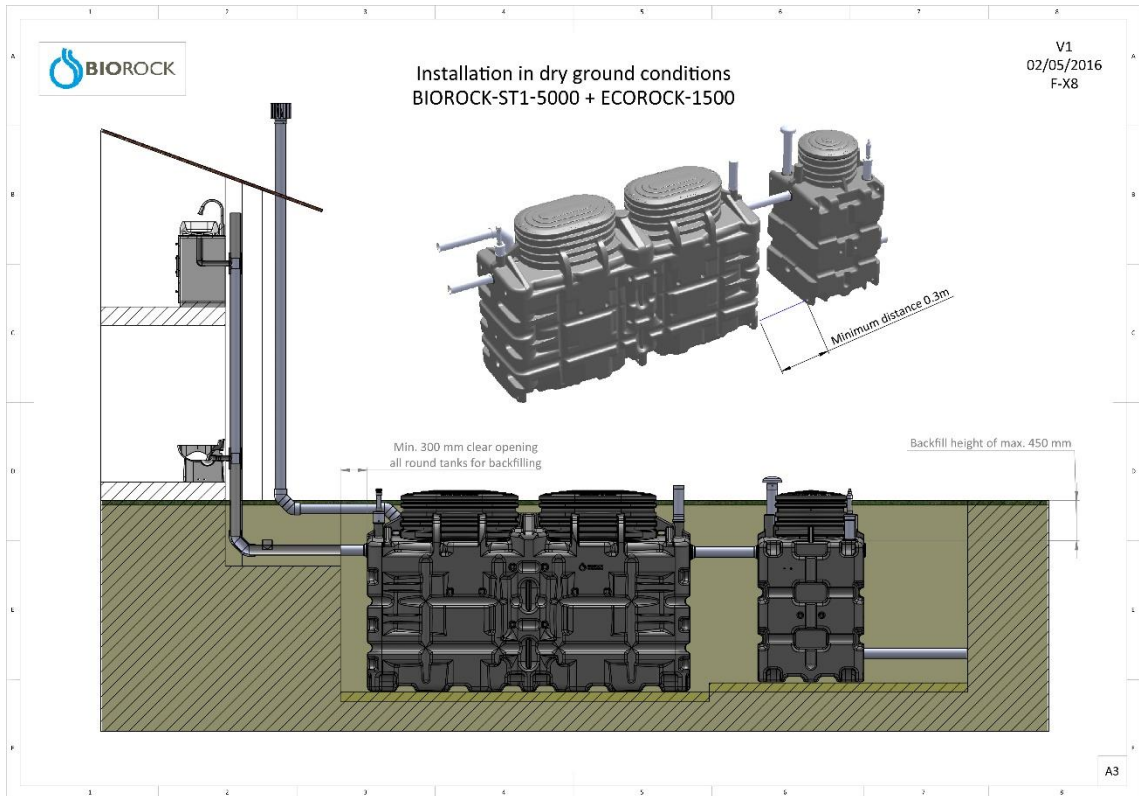

APPENDIX 2

2.4

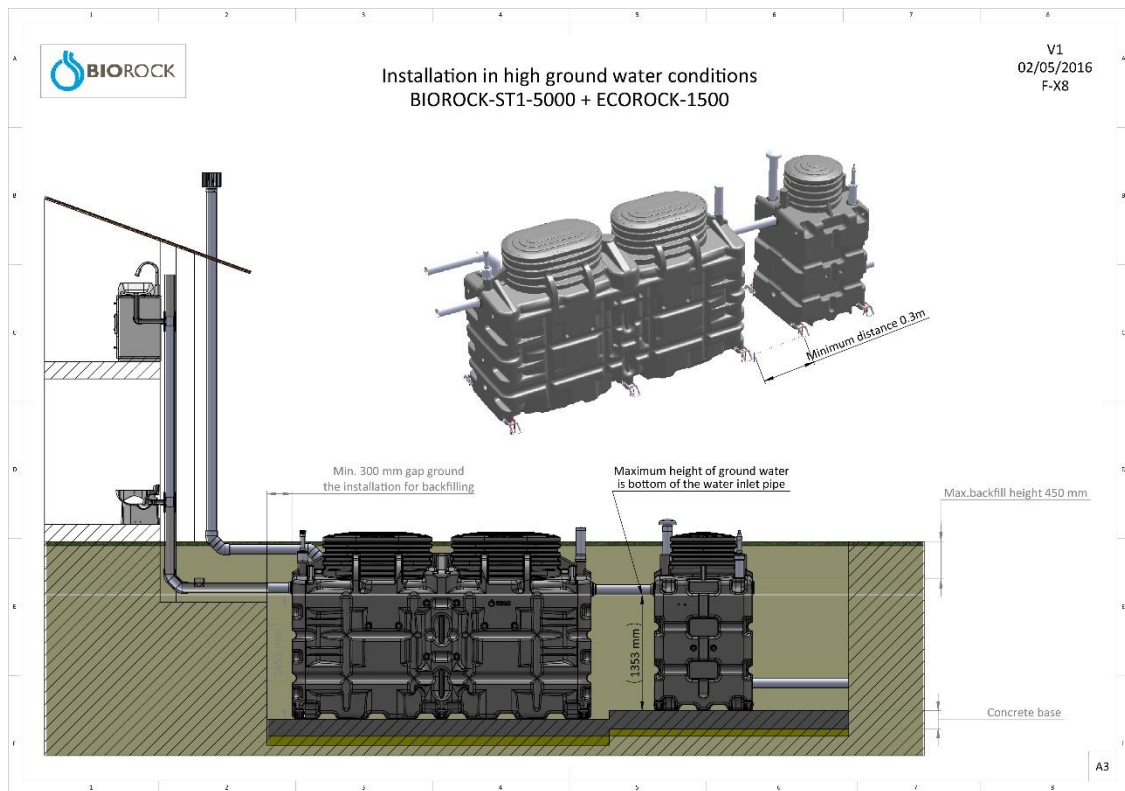

APPENDIX 2

2.5

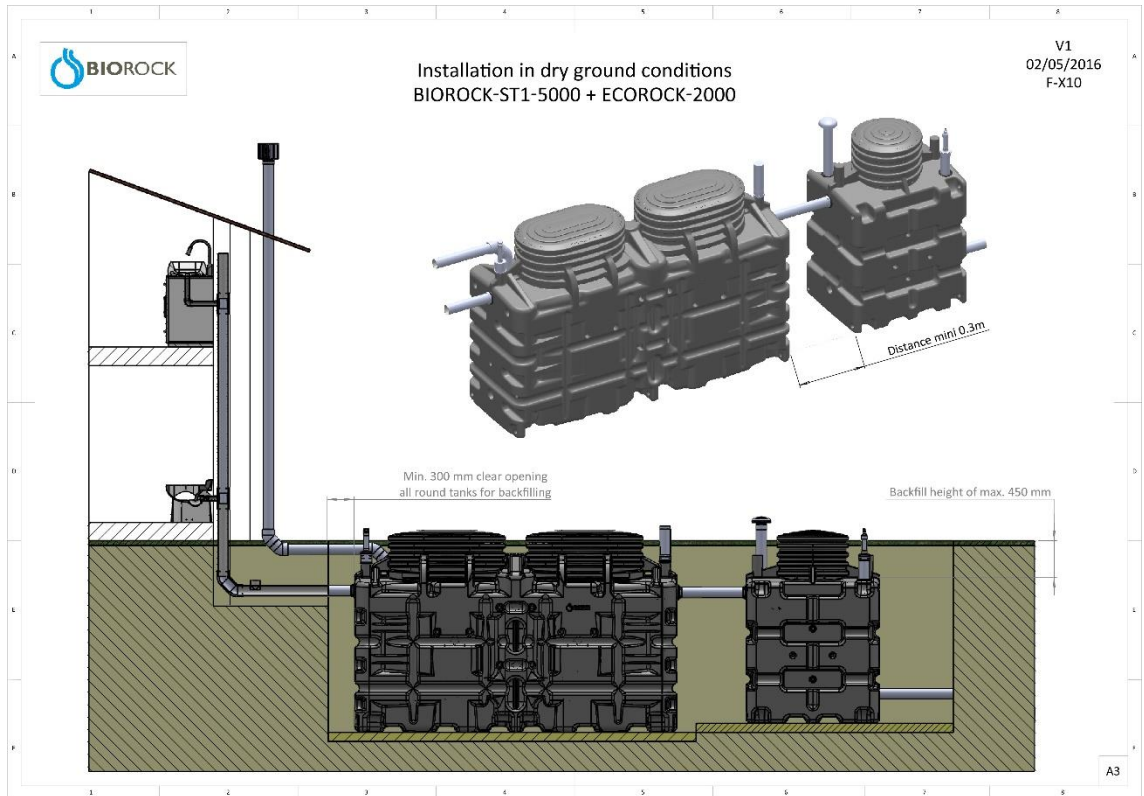

APPENDIX 2

2.6

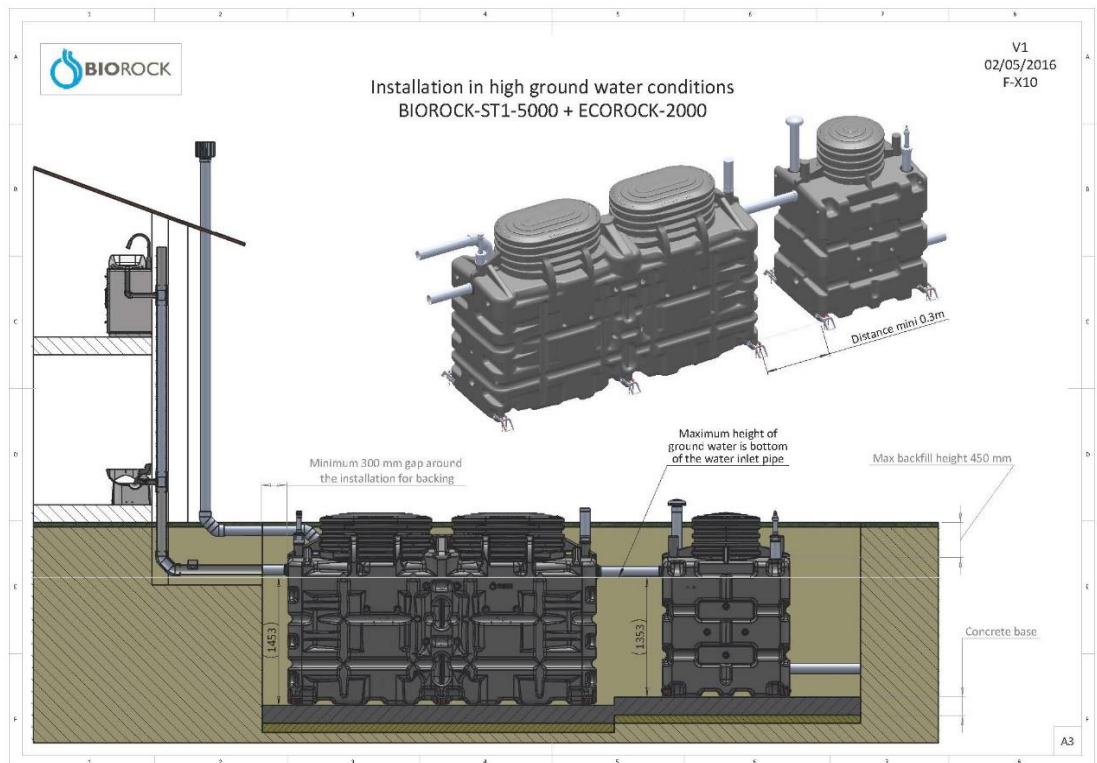

APPENDIX 2

2.7

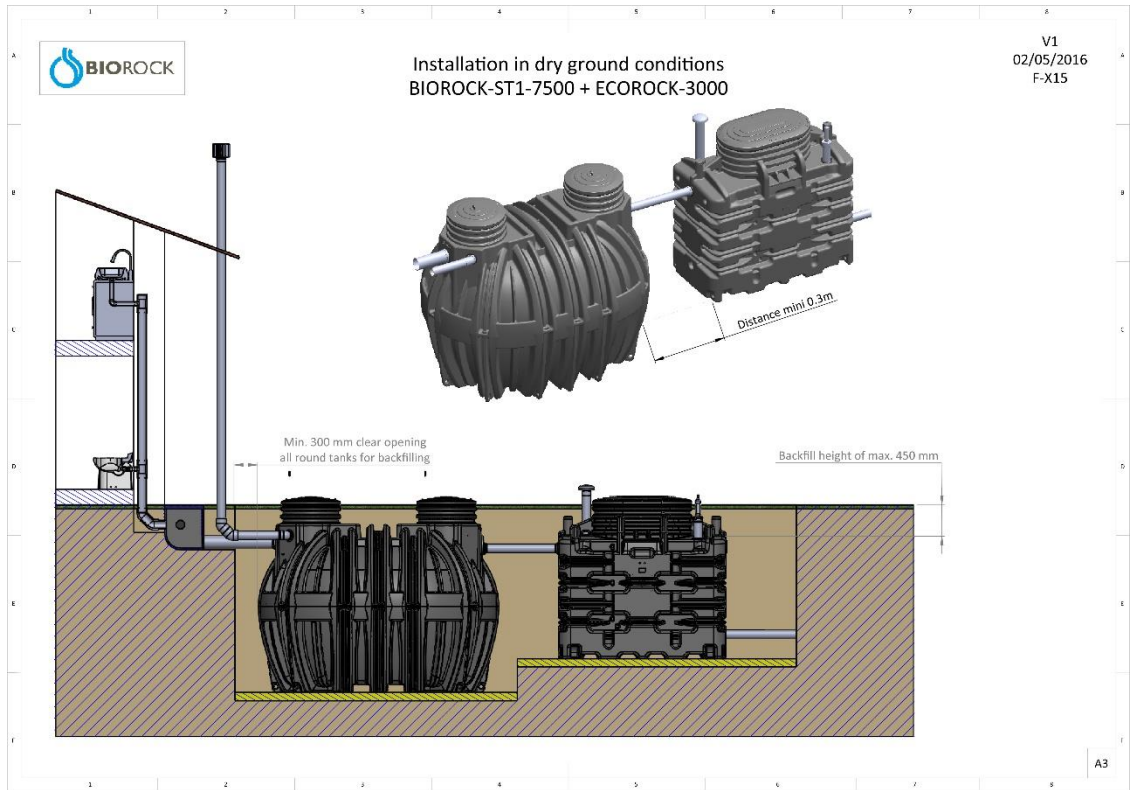

APPENDIX 2

2.8

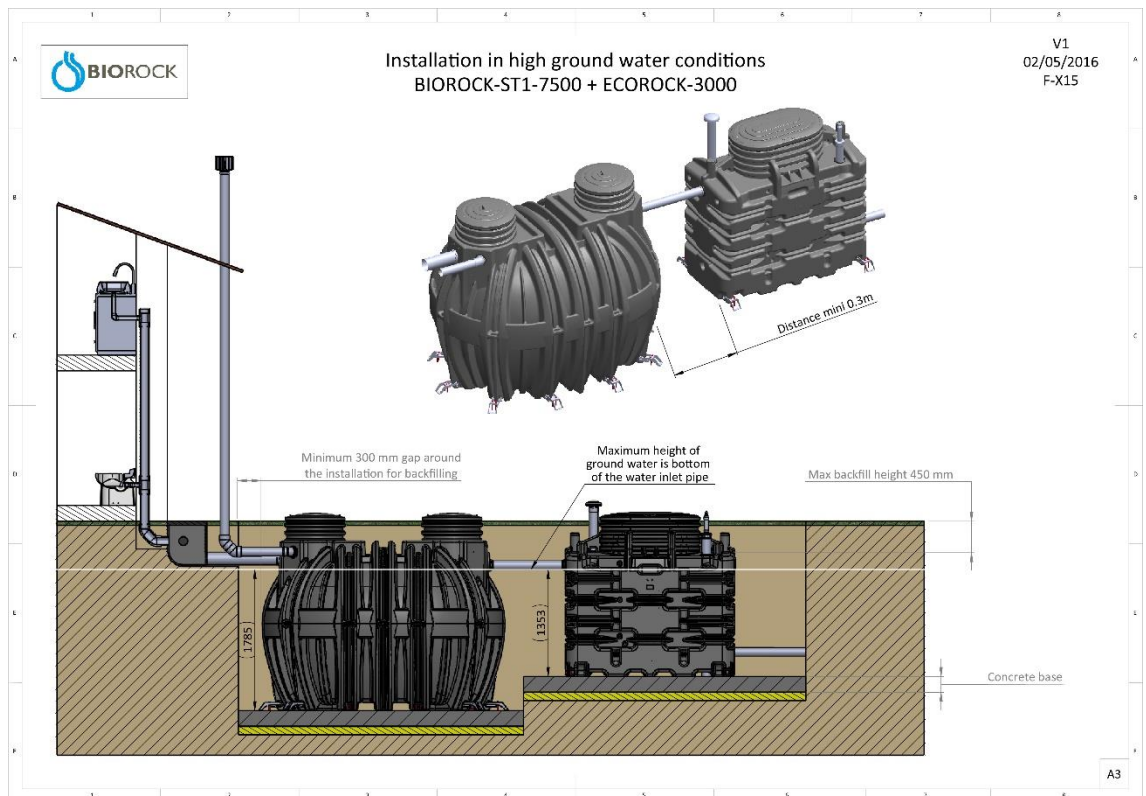

APPENDIX 4

MAINTENANCE AND ACTIONS FORM

To be completed – TO BE KEPT BY THE USER

DATE OF FIRST COMMISSIONING: / /

Product N° of tank: (see page 9 in the user's guide)

Warning:

Please keep sludge emptying documents and proofs validated by the contractor.

DATE	WHAT HAS BEEN DONE	USER'S NAME	COMMENTS

If you have not subscribed to any maintenance agreement, please ask a trained, professional contractor to provide maintenance and any work required on your sewage treatment plant.



APPENDICE 5

ACTIVATION OF THE WARRANTY

(see our conditions)

Important information: If this form isn't returned to BIOROCK within 120 days the installation of the system, there will be no warranty at the system

INSTALLATION FORM FOR A BIOROCK SYSTEM

This form must be completed and returned to:

BIOROCK S.a.r.l.
 Z.A.E. Robert Steichen
 5, rue Bommel,
 L-4940 HAUTCHARAGE (Luxembourg) or by e-mail : info@biorock.com
PLEASE KEEP ONE COPY FOR YOURSELVES.

DISTRIBUTOR :

NAME :

ADDRESS :

.....

Type of installation:

- ECOROCK-1500 ECOROCK-2000
- ECOROCK-3000 ECOROCK-5000
- Other :

Installation date :

Commissioning date:

Installer

NAME.....

INITIALS.....

Address

.....

TEL :.....

E-mail.....

OWNER

Name.....

Initials.....

Address

.....

Tel.....

E-mail.....

New built home Existing home

Adresse of the installation if different than owner

Name.....

Initials.....

Address

.....

Tel.....

E-mail.....

New built home Existing home

Please indicate :

- ♦ **Nature of building:** ♦ **Number of rooms :** ♦ **Number of occupants :**
- Soil conditions:** Dry High ground water Difficult On a slope Other:
- Discharge:** Infiltration Water course Re-use Other:

Type & Capacity of the Primary Tank: **Serial number:**

Type & Capacity of the BIOROCK unit: **Serial number:**

- Ventilation:** Windriven ventilator Electrical
- Pump?:** After Primary Tank After BIOROCK Reactor

Declaration :

- The BIOROCK® system is installed and commissioned in accordance with:
- The current legislations stating the technical requirements applicable to domestic sewage treatment plants in the territory where the system has been installed
 - Installation, use and maintenance requirements of the Primary Tank and ist Effluent Filter, indicated in the Instruction Manual as provided by your supplier
 - Current installation, use and maintenance requirements of the BIOROCK System

Signed at :..... on

Signatures :

The Owner :

Name of the responsible Authority:
(if applicable)

The installer:

