



USER'S GUIDE

MONOBLOCK-2 V3

Capacity up to 600 l/d

July 2024

Dear customer,

We would like to congratulate you on your purchase.

The BIOROCK® Domestic Sewage Treatment Plant ensures you comfort and peace of mind over time and is environment friendly.

We strongly recommend that you carefully read and follow the instructions in the Installation Guidelines **(A)** and the User Guide **(B)** in this User's Manual.

Follow the instructions for maintenance and visual checks to keep the device working properly. Please do not hesitate to contact your BIOROCK distributor for any queries or further assistance.

Thank you for choosing BIOROCK.

PLEASE READ CAREFULLY

We advise you to call in a professional for the installation and commissioning of your system.

For the annual maintenance tasks, the BIOROCK after-sales service offers you a maintenance contract for your sewage treatment plant.

If you do not wish to subscribe to a maintenance contract, it is strongly advised to call upon a qualified professional for the maintenance work and for any intervention to be carried out on the equipment of sewage treatment plants.

BIOROCK® SARL

4-5 Zone d'Activités Economiques
Le Triangle Vert
L-5691 ELLANGE – Luxembourg

Email : info@biorock.com

Tel : 00 352 26 65 00 26

Distributor's Name:

Contact:

Stamp of the company:

GENERAL TABLE OF CONTENTS

A	INSTALLATION GUIDELINES.....	5
B	USER'S GUIDE.....	35
C	APPENDICES.....	54

A

Installation guidelines

MONOBLOCK-2 V3 Capacity up to 600 l/d



TABLE OF CONTENTS

1.	THE TREATMENT SYSTEM	7
1.1	OPERATING PRINCIPLE.....	7
1.2	USAGE	9
1.3	IDENTIFICATION AND TRACEABILITY	10
1.4	HANDLING AND TRANSPORTATION OF THE TANKS	11
2.	STANDARD INSTALLATION DIAGRAMS.....	12
3.	INSTALLATION OF THE WORKS.....	13
3.1	GUIDELINES AND CONSTRAINTS FOR THE INSTALLATION OF WORKS	13
3.2	INSTALLATION ON DRY GROUND	15
3.3	INSTALLATION IN WET GROUND	17
3.4	INSTALLATION IN DIFFICULT TERRAIN.....	20
3.5	INSTALLATION UNDER ROADWAY, YARD OR STORAGE AREA	22
3.6	OTHER SPECIAL CASES.....	23
3.7	EXTENSIONS AND LIDS ACCESSORIES	23
4.	COMMISSIONING	30
5.	CONFORMITY OF THE WORKS AND REPORT OF THE END OF THE WORKS	33
6.	WARRANTIES	34

1. THE TREATMENT SYSTEM

1.1 OPERATING PRINCIPLE

The MONOBLOCK V3 is a domestic sewage treatment plant using the BIOROCK® process integrated inside a polyethylene tank. This treatment system is made up of a primary treatment tank divided into two compartments and a secondary treatment tank (see Appendix 2).

PRIMARY TREATMENT or MONOBLOCK V3 PRIMARY TANK

The untreated domestic wastewater, a mixture of household wastewater (kitchen, bathroom, laundry, etc.) and black water (WC), flows from the collection chamber at the bottom of the house to the primary treatment tank.

An air inlet is provided by the wastewater inlet pipe ($DN \geq 100$ mm), extended in primary ventilation to the open air and above the roof of the house. The system has an additional ventilation that is essential to the process since it ventilates the filter (see details below).

Grease and other floating matter are separated at the surface while the settleable matter accumulates at the bottom of the tank, forming sludge. This sludge is digested and liquefied during the months of storage by anaerobic fermentation. The installation of an effluent prefilter at the exit of the tank allows to trap the suspended matter (colloids) to obtain a better quality at the exit of the primary treatment.

SECONDARY TREATMENT or MONOBLOCK V3 TREATMENT UNIT

The MONOBLOCK V3 treatment unit is an aerobic biological treatment system of the bacterial bed type using BIOROCK® filtration media.

The pre-treated water leaving the tank flows to the distribution system, consisting of a bi-directional tipping tray and a distribution tray, which feeds the trickling filter bed. The water percolates through 3 layers of media: the top and bottom layers are made of polyethylene rings and the middle layer is made of BIOROCK® media.

The BIOROCK® media has a double function: it is a support for the bacterial biomass that degrades the carbonaceous pollution and also acts as a filter to retain the formed sludge. Like the BIOROCK® media, the polyethylene rings serve as a bacterial support and also have the function of promoting the air/water exchanges necessary for the supply of oxygen to the system.

Oxygen is essential to the oxidation reactions by the biomass. The natural ventilation of the bacterial bed allows to maintain this supply. The ventilation circuit starts with 2 entry points: at the surface and at the bottom of the bed. The air at the bottom of the bed is drawn in by the chimney effect created by the trickling filter bed, while the height differential between the air inlet and outlet creates a flow from the surface of the bed to the outlet of the extractor via the primary tank. The gases emitted in this tank by the anaerobic fermentation

A. INSTALLATION GUIDELINES

of the sludge are thus evacuated, avoiding any smell emission.

At the exit of the bacterial bed, the effluent flows by gravity. Depending on the installation constraints and the water lines of the installation, a pumping station (supplied as an option) can complete the downstream system.

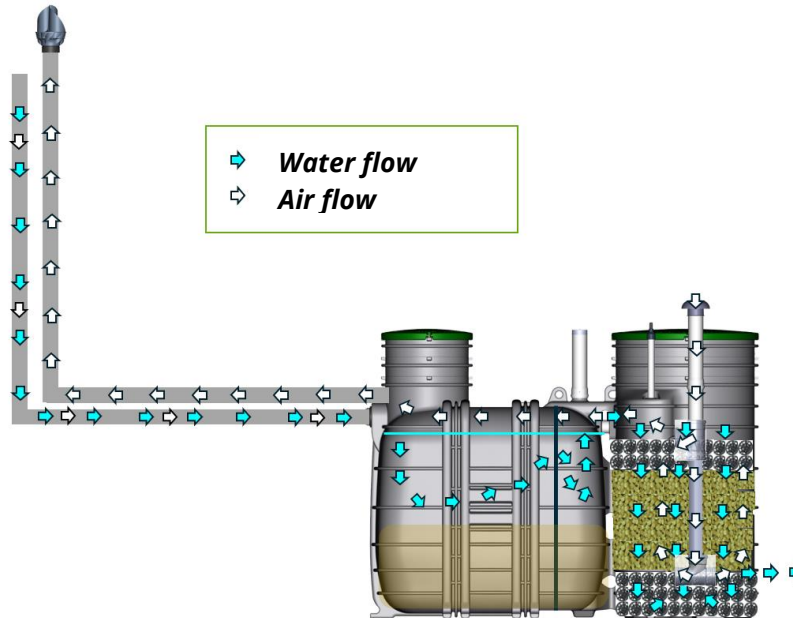

Diagram of the water circulation and ventilation

It is mandatory to allow sampling at the effluent outlet. If the location does not allow direct access, a sampling chamber (supplied as an option) must be installed at the outlet of the treatment tank.

MODEL PARAMETERS	MONOBLOCK-2 V3
PRIMARY TANK VOLUME	2 m ³
SEWAGE VOLUME TO BE TREATED	600 L/day
TREATED ORGANIC LOAD OF DBO5	0,24 kg/day

1.2 USAGE



Important precautions for the correct operation of the systems: The MONOBLOCK V3 is exclusively intended for the treatment of **biodegradable domestic wastewater**, i.e. black water and domestic wastewater.

It is advisable to avoid the use of automatic toilet cleaners, sink grinders or grinder pumps. Do not dispose of non-degradable solid waste in the home's sewage system.

It is forbidden to discharge certain products into the installation so as not to affect its purification performance, such as

- Motor oils, waxes, resins, paints, solvents, hydrocarbon-based products (gasoline, petroleum, etc.), any pesticide, any bactericide, any toxic product, acid and base product. These must be evacuated to a collection and sorting center.
- Condensation water from boilers, air conditioners, water from backwash of softeners, water from backwash of swimming pools, will be evacuated according to the manufacturer's instructions.
- Rainwater, runoff, drainage water, floor drains and gutters will be directed towards the rainwater network.
- Recommended biological or chemical activators for the primary tank.



The use of household products such as dishwashing liquid and household cleaners is tolerated in moderation.

If the system is far from the kitchen water (> 10m), it is recommended to install **a grease trap** (supplied as an option).

1.3 IDENTIFICATION AND TRACEABILITY

Before installing, it is imperative to copy the serial number of each tank on the documents to be kept by the customer in Appendix 4 and 5 of this User's Guide.

When you look at the tank facing the BIOROCK® , the serial number can be found:

- On an identification plate inside the tank, indicated by this mark on  the figure below
- Engraved on the face located on your right in the bottom of the top rounding; indicated by this  mark on the figure below

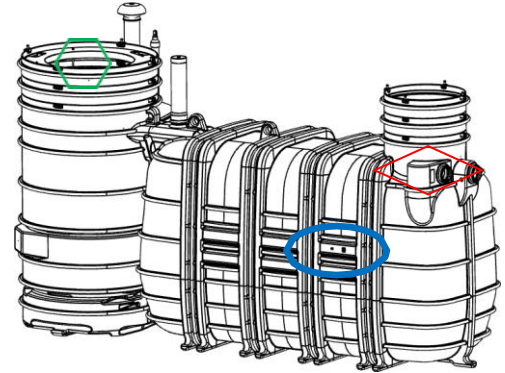

Here is the detail of the identification plate inside the tank: (standard plate)

Name + Number of Independent Testing Platform →		BIOROCK ← Factory ID Luxembourg
	CSTB 0679 PIA 1739	21 ← CE Mark (year) DoP 2022-03 ← Performance declaration
Product usage →	EN 12566-3+A2 ← Standard Reference Small Wastewater treatment plant	
Material →	MONOBLOCK-2 V3 ← Name	
	0,6 m ³ /j ← Capacity	
	xxxxxxxx ← Serial number	
	HDPE	

1.4 HANDLING AND TRANSPORTATION OF THE TANKS

The handling of the tank is possible in the upper part with the help of 2 lifting points molded into the tank as shown in the diagram below.

A label  on the tank reminds you of the tank lifting instructions.

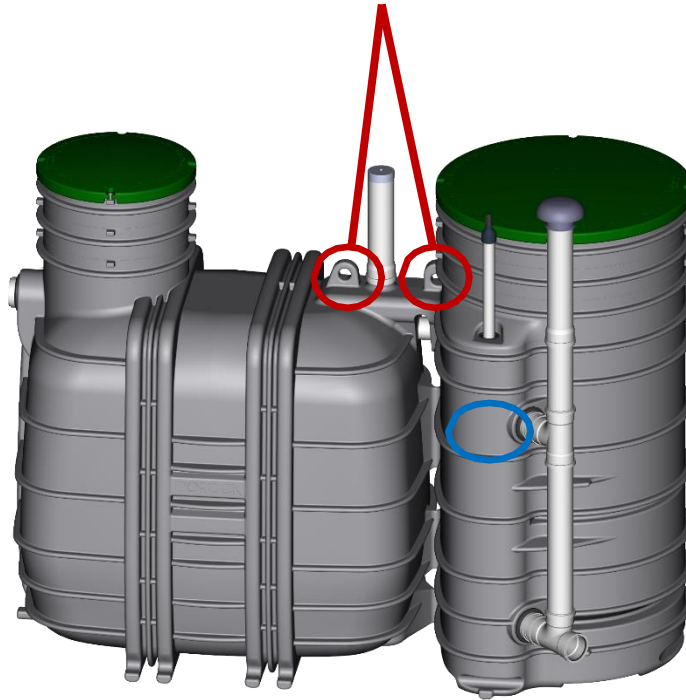

After delivery to the site, the equipment must be transported, stored and handled in such a way that it is protected from any action, particularly mechanical action, which could cause damage. Make sure that the tank is kept horizontal during the various handling operations.

Technical data for tank handling:

- Tank dimensions with lids : 2830 x 1150 x 2088 mm (L x W x H)
- Tank weight: **295 KG**

2. STANDARD INSTALLATION DIAGRAMS

The system installation will depend, among other things, on the available location, the slope and the nature of the land, the effluent outlet level and the topography of the receiving environment of the treated wastewater in accordance with the amended decree of September 7, 2009 on "technical requirements".

The purification performance of the system can be determined by taking a sample of the treated wastewater. When the treated water outlet is not accessible, it is sufficient to position a watertight collection manhole to collect the water.

When the treated effluent outlet is not accessible, it is necessary to install a **sampling manhole** (supplied as an option). The sampling manhole must have a diameter of at least 400 mm and must be equipped with a watertight lid, its closing must be secured. The installation conditions of the sampling manhole must follow the recommendations for the installation of the MONOBLOCK V3 system described below.

Depending on the nature of the land, it may be necessary to discharge the treated water to the outlet via a pumping station (supplied as an option). This station is independent of the treatment unit, connected to it only by the hydraulic connection pipe. In this case, the sampling can be done in the station.

• INSTALLATION DIAGRAM N°1

GRAVITY INSTALLATION WITH ACCESS TO THE TREATED WATER



• INSTALLATION DIAGRAM N°2

INSTALLATION WITH PUMPING STATION (Option)



Key:

CM: Collection manhole. Necessary if the treated water outlet is not accessible.

PS: Pumping station (supplied as an option)

A pumping station (supplied as an option) located downstream of the system must comply with the requirements of the standards in force:

- The treated water at the outlet of the device is elevated to a minimum height of the declared groundwater level (*see Annex 1: groundwater level = water line, i.e. 1340mm*)
- The pump must be easily accessible, so as to allow all necessary interventions and must not be equipped with macerator devices
- The electrical installation must comply with the requirements of the national standard,
- The pump delivery pipe must be equipped with a non-return valve.

3. INSTALLATION OF THE WORKS

This chapter is a guide to the installation, the setting up and the commissioning of the various works constituting the system. The present manual can in no way replace the documentation and manuals of the manufacturer of non-BIOROCK® products integrated into the structure by the user. The collection and evacuation of domestic wastewater in the building up to the treatment system must be carried out in accordance with good practice.

3.1 GUIDELINES AND CONSTRAINTS FOR THE INSTALLATION OF WORKS

You can find all the technical characteristics and dimensions of the tanks in **part C** of this guide.

SIZE OF THE EXCAVATION

NAME	CAPACITY	WIDTH (including backfill)	LENGTH (including backfill)	Minimum surface of the excavation
MONOBLOCK-2 V3	600 l/d	1,80 m	3,40 m	6,12 m²

The structures are installed underground (or assimilated underground) and must be installed in such a way as to limit the height of the backfill and the topsoil on them. The **maximum height of backfill** on the tank roof must not exceed **450 mm** (see Appendix 1.).

The maximum depth of the excavation is the height of the bottom of the excavation (see 3.2, 3.3 or 3.4 depending on the conditions of installation) added to the total height of the tank and the height necessary to reach the level of the natural ground.

The distance between the vertical walls of the excavation and the vertical walls of the installation shall be **at least 300 mm** at any point of the structure.

The **difference in level** between the raw water inlet and the treated water outlet is **1130 mm**.

PLACEMENT OF THE SEWAGE TREATMENT PLANT ON THE PLOT OF LAND

The implementation of the system must meet the following requirements:

- A minimum distance of 35 meters from **a declared water catchment** intended for human consumption, except in special situations specified in the "technical prescription" decree of September 7, 2009, as amended.
- A minimum distance of **3 meters** from areas intended to receive rolling/permanent/temporary loads (areas intended for the **circulation** and **parking** of

A. INSTALLATION GUIDELINES

any vehicle - except in the case of implementation in particular conditions under static or rolling load, see A.§3.5).

- A maximum distance of **15 meters** between the air intake of the unit and the **vertical ventilation duct** of the air outlet. Note that the air outlet on the roof must be kept away from any vegetation.

The following diagram also shows several minimum distances to be respected:

- A minimum distance of **3 meters** from plantations (trees or other vegetation) with significant root systems. This distance applies :
 - to the tanks,
 - to air inlet and outlet vents.

Below this distance, a protection system is required.

- A minimum distance of **3 meters** from unfounded storage areas.
- The minimum distance from the device is **5 meters***, in accordance with good engineering practice, between the tank and a well-founded structure. If the distance between the tank and a founded structure is less than 5 meters, a study must be carried out by a competent engineering office.
- The distance between **the point of discharge** of the wastewater to be treated and the tank inlet should be as short as possible, preferably less than **10 meters**, to avoid clogging by grease in the inlet pipe. Beyond 10 meters, it is recommended to install a grease trap (supplied as an option).

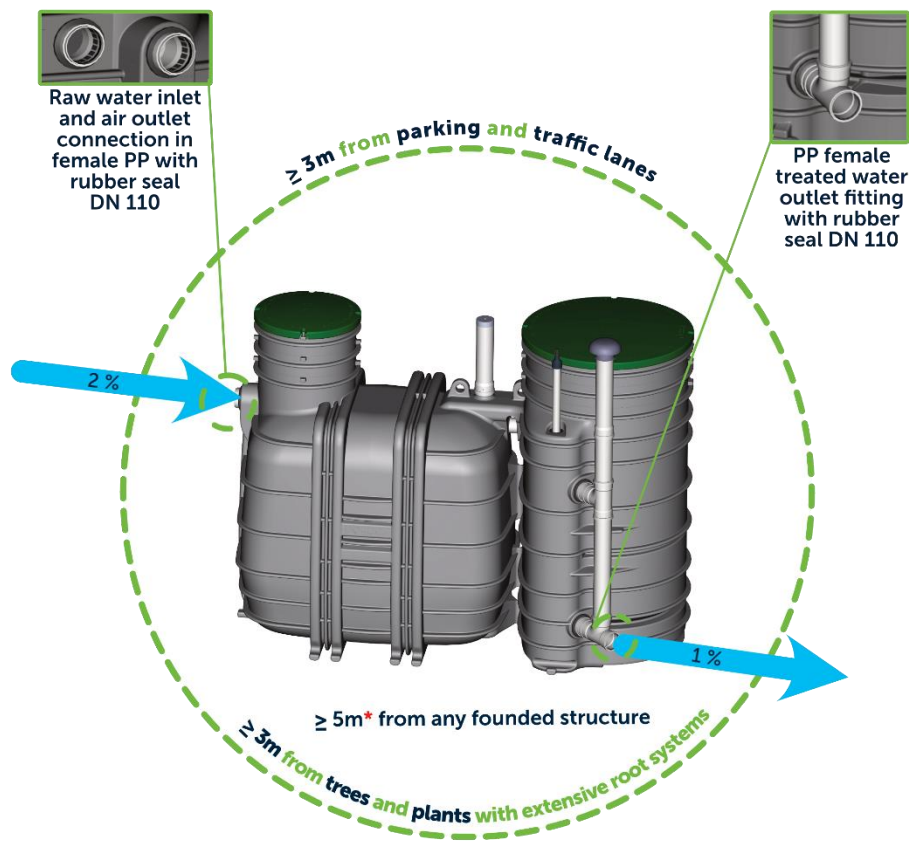

Installation recommendations

- In accordance with the regulations, trenches deeper than 1.30 m and less than or equal

A. INSTALLATION GUIDELINES

to two thirds of the depth, must be equipped with shoring (or embanked) to ensure the safety of people and the maintenance of the structure of the land.

- The **junctions** of the MONOBLOCK V3 system (supply and evacuation) are made by the installer in a watertight manner by **interlocking with flexible jointed pipes** (in synthetic rubber) **of 110 mm diameter**. The choice of pipe diameters should be at least 100 mm in diameter.

In case of junction of different diameters, a modification adapted to the difference of sections will be necessary. In case the materials between the two fittings are different, a universal EPDM fitting with stainless steel clamp is necessary (e.g. when the desired size reduction is not available).

- The slope of the sewage inlet pipe must be at least **2%**.
- The discharge of the treated sewage must be carried out in accordance with local legal provisions.

3.2 INSTALLATION ON DRY GROUND

Appendix 1.1 "System Installation and Maintenance Plan - Dry Ground Installation"

❖ Installation conditions :

- Healthy and good bearing capacity soil
- Absence of water at the level of the invert of the structures (ground above the groundwater)

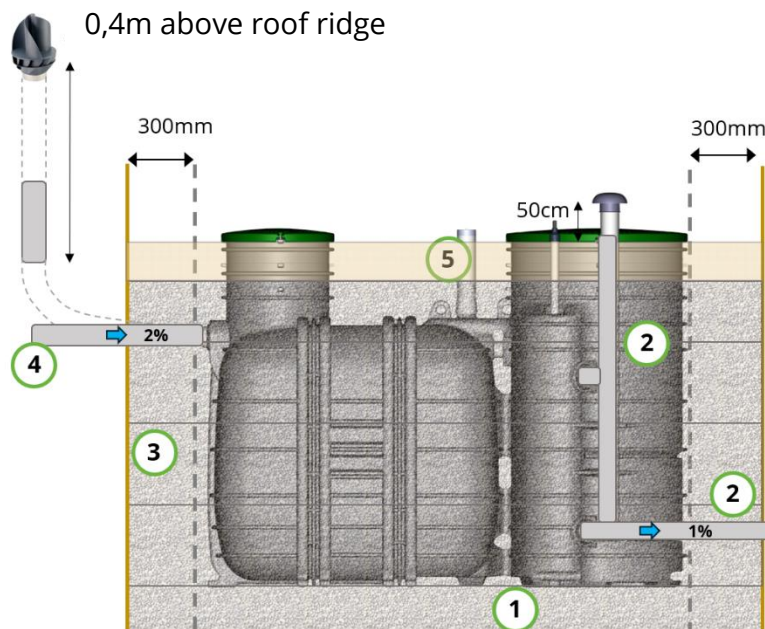

3.2.1. Excavation and bottom of excavation in dry ground

- It is imperative to foresee a selective storage during the excavation of the topsoil, this one will be reused for the last 20 centimeters of covering of the treatment device.

A. INSTALLATION GUIDELINES

- The works must rest on a clean, healthy and good bearing soil. The soil of the bottom of the excavation must have mechanical properties making it suitable for the work. All the elements met in bottom of excavation and likely to constitute hard points, such as rocks, vestiges of foundations, must be removed. Any pocket of peat, silt or other material of poor bearing capacity must be purged and replaced by a good quality backfill.
- The depth of the bottom of the excavation must allow the implementation of **a slope of at least 2%** on the raw domestic sewage pipe, for the connection between the sewage outlet and the treatment plant.
- **The bottom of the excavation will be made of compacted sand, with a minimum thickness of 100 to 300 mm (1).** The bottom of the excavation shall be **perfectly leveled** (flatness and horizontality of the installation bed must be ensured) and carefully compacted to avoid subsequent settling. The walls of the excavation shall be at least 300 mm apart from the pipe at all points.

3.2.2. Installation of the device on dry ground

- Once the bottom of the excavation has been stabilized, place the system on the bottom of the excavation, horizontally in the direction of the flow. Make sure that it is well wedged and level.
- Connect the **water outlet and air inlet pipes (2)** in a watertight manner in accordance with the installation instructions.

3.2.3. Backfilling in dry ground

- Backfill in **successive 300 mm layers with 0/4 sand or 4/6 gravel (3)**, filling the **primary** treatment tank with clear water as soon as backfilling begins, in order to balance the pressures.
- This backfill layer should be carefully compacted (mechanical compaction is not allowed) to avoid subsequent settling and deformation of the tanks.
- Repeat the backfilling operation with filling and manual compaction until the sewage inlet pipe is reached.
- The final backfill must cover the pipes and any extensions with sufficient backfill height to allow for subsequent settling.
- Check that the system is leveled. **Connect the sewage inlet and air outlet pipes (4)** in a watertight manner.
- The ventilation must be carried out carefully, without any counter-slopes, without 90° PVC bends (preferably using bends of 45° or less) as straight as possible.

The air extraction pipe from the septic tank must be :

- vertical and independent,
- with a minimum diameter of 100 mm,
- necessarily equipped with an extractor (static or wind) located at least 400 mm above the roof ridge
- at least 1 meter away from any opening and any other ventilation or any other obstacle.

Moreover, the minimum distance between the inlet (treatment unit side) and the air outlet (all water tank side) must be 1m.

A. INSTALLATION GUIDELINES

3.2.4. Finalizing the site on dry land

- Place the lids and secure them by tightening the screws on the top. Make sure that the joints of each lid are well positioned and intact.
- Continue backfilling with sand or gravel up to 200 mm below the lids (a total of 1800 mm of sand or gravel from the bottom of the tank).
- The surface backfilling of the devices is carried out with topsoil (maximum thickness 200 mm) free of all stony or sharp elements to avoid alteration of the lids (5).
- The final backfill must allow all buffers and closure devices to remain visible and flush with the finished ground level without allowing runoff to enter.
- In addition, it must ensure that the pipes and any extensions are covered with sufficient backfill height to allow for subsequent settling.
- Lids shall not be buried and shall remain accessible for maintenance.

3.3 INSTALLATION IN WET GROUND

Appendix 1.2 "System Installation and Maintenance Plan - Wet Ground Installation"

❖ Installation conditions:

- Wet ground, presence of groundwater
- Presence or variation of water table, etc. The bottom of the excavation must be dried out before any work is carried out, and kept out of water during the work.

The MONOBLOCK V3 is also designed for installation in a humid environment.

The treated water leaving the device is then elevated to a minimum height of the declared groundwater level and a downstream pumping station (supplied as an option) is necessary in the presence of groundwater (installation in wetland conditions)

If a pumping station (supplied as an option) is required downstream of the treatment unit, it must meet the following requirements :

- The characteristics of the downstream pump station (supplied as an option) must comply with standard EN 12050-2. In wet conditions, substation specifications must comply with the requirements of standard EN 12050-2, tested in wet conditions.
- The treated water at the outlet of the unit is elevated to at least the declared height of the groundwater table (see Annex 1)
- All precautions must be taken to prevent the collection tank from rising, especially when the ground may be waterlogged (e.g. ballasting, anchoring, etc.),
- The primary tank must be ventilated
- The pump must be accessible to allow all necessary interventions and must not be equipped with dilacator devices.
- The electrical installation must comply with the IEC 60364 standard,
- The pump delivery pipe must be equipped with a non-return valve.
- The connections of the effluent pipes are made in a watertight way, and the junction between the treatment device and the pumping station (supplied as an option) must be implemented in order to avoid any water infiltration, and particularly during a rise of the water table.

During operation, the rise in the water table must not exceed the water line (1340 mm from the bottom of the tank).

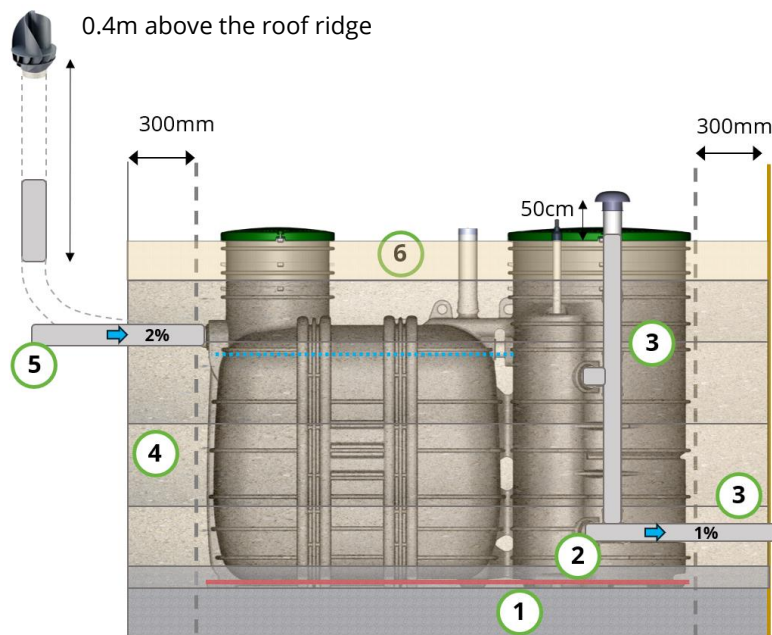

3.3.1. Excavation and bottom of excavation in wet ground

- It is imperative to foresee a selective storage during the excavation of the topsoil, this one will be reused for the last 200 millimeters of covering of the treatment device.
- The works must rest on a clean, healthy and good bearing soil. The soil of the bottom of the excavation must have mechanical properties making it suitable for the work. All the elements met in bottom of excavation and likely to constitute hard points, such as rocks, vestiges of foundations, must be removed. Any pocket of peat, silt or other material of poor bearing capacity must be purged and replaced by a good quality backfill.
- The excavation shall be kept dry during the excavation and until the end of the earthwork.
- The depth of the bottom of the excavation must allow **a slope of at least 2%** to be applied to the raw domestic sewage pipe for the connection between the sewage outlet and the sewage system. The walls of the excavation will be at least 300 mm away from the works at all points.
- Make a **reinforced concrete slab** at the bottom of the excavation (flatness and horizontality must be ensured) with a **minimum thickness of 200 mm** on a geotextile mat. This concrete slab extends at least 300 mm all around the system.
- The characteristics of the concrete slab (positioning, reinforcement, dimensions, thickness...) must be determined by a design office so that these elements meet the requirements for which they are intended **(1)**.

A. INSTALLATION GUIDELINES

- The anchoring of the tank is done by positioning 2 x Tor iron of 10 mm diameter all around the tank at the level of the legs of the MONOBLOCK V3 (2).

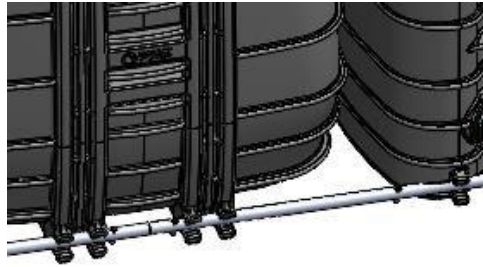

MONOBLOCK V3 anchoring principle

3.3.2. Installation of the device in wet ground

- Once the slab is ready, place the device on the bottom of the excavation, horizontally in the direction of the flow. Make sure that it is well wedged and leveled.
- Place concrete around the tank to a thickness of 100 mm in order to trap the Tor iron in the concrete (2).
- Once the concrete is dry, **connect the water outlet and air inlet pipes of the filter (3)** in a watertight manner in accordance with the installation instructions.

3.3.3. Peripheral backfill in a wet ground

- Perimeter backfilling is carried out in **successive 300 mm layers using 4/6 mm gravel or stabilized sand (0-4 sand with cement, dosed at 200 kg cement per m³ of sand) (4)**, while filling the primary treatment tank with clear water from the beginning of the backfill in order to balance the pressures.
- This backfill layer should be carefully compacted (mechanical compaction is not allowed) to avoid subsequent settling and deformation of the tanks.
- Repeat the backfilling operation with filling and manual compaction until the sewage inlet pipe is reached.

▪ In the case of gravel backfill, we recommend installing a drainage system with a decompression well to preserve the integrity of the tank in all circumstances. It is advisable to install two piezometers made from DN 315 mm PVC pipes, so as to be able to measure the level of the water table and draw it down during emptying operations. The piezometer tubes are positioned at the ends of the excavation as shown in the diagram opposite. The piezometers are interconnected at the bottom by DN100 spreader drains with their slots positioned downwards. If required, DN100 female-female PVC elbows can be fitted to facilitate installation, as shown in the diagram opposite. The entire system, comprising piezometer tubes and

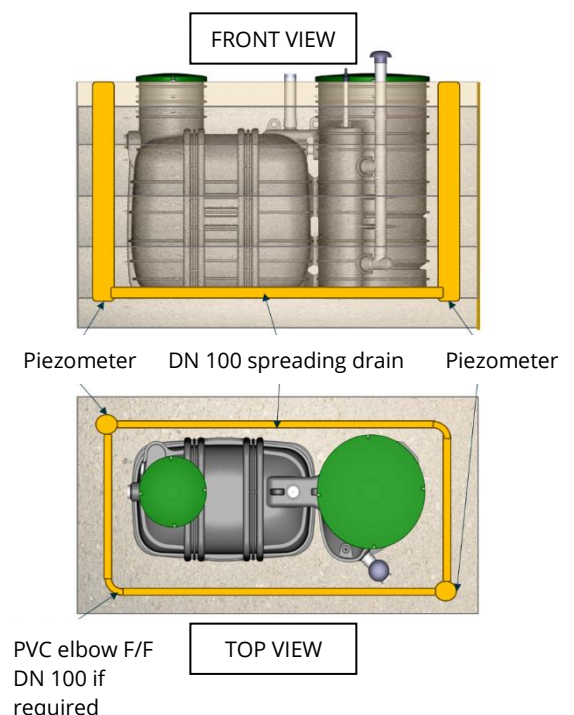

A. INSTALLATION GUIDELINES

DN100 drains, is laid on the concrete base surrounding the tank and enclosing Fer Tor, as described in section 3.2.2. Backfill with 4/6 gravel in successive 300 mm layers, while filling the tank with clear water as described above.

- Check that the system is properly levelled. Connect **the sewage inlet and air outlet pipes (5)** tightly.
- Ventilation must be carried out carefully, without slopes, without 90° PVC bends (preferably using bends of 45° or less) as straight as possible.

The air extraction pipe from the septic tank must be :

- vertical and independent,
- with a minimum diameter of 100 mm,
- necessarily equipped with an extractor (static or wind) located at least 400 mm above the roof ridge
- at least 1 meter away from any opening and any other ventilation or any other obstacle.

The minimum distance between the air inlet and outlet must be 1m.

3.3.4. Finalizing the work in the Wetland

- Place the lids and secure them by tightening the screws on top.
- Continue backfilling with 4/6 gravel or stabilized sand (0-4 sand with cement, dosed at 200 kg cement per m³ sand) up to 200 mm below the lids (a total of 1800 mm of stabilized sand height from the bottom of the tank).
- The surface backfill of the devices is made with topsoil (maximum thickness of 200 mm) cleared of all stony or sharp elements to avoid alteration of the lids **(6)**.
- The final backfill must allow all buffers and sealing devices to remain visible and flush with the finished ground level without allowing runoff to enter.
- In addition, it must ensure that the pipes and any extensions are covered with sufficient backfill height to allow for subsequent settling.
- The lids shall not be buried and shall remain accessible for maintenance.

3.4 INSTALLATION IN DIFFICULT TERRAIN

❖ Installation conditions:

- Difficult terrain (presence of clays, rocks, etc.)
- In case of difficult terrain, the bottom of the excavation must be drained before any work is carried out, and kept out of water during the work, the excavations must be protected against possible landslides, and/or the bottom of the excavation must be purged of any unhealthy material or hard point.

A. INSTALLATION GUIDELINES

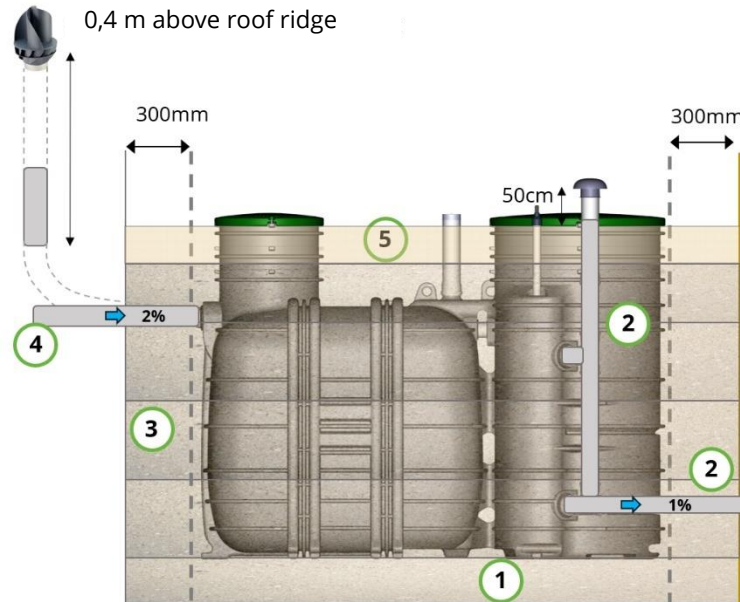

3.4.1. Excavation and bottom of excavation in difficult terrains

- It is imperative to foresee a selective storage during the excavation of the topsoil, this one will be reused for the last 200 millimeters of covering of the treatment device.
- The works must rest on a clean, healthy and good bearing soil. The soil of the bottom of the excavation must have mechanical properties making it suitable for the work. All the elements met in bottom of excavation and likely to constitute hard points, such as rocks, vestiges of foundations, must be removed. Any pocket of peat, silt or other material of poor bearing capacity must be purged and replaced by a good quality backfill.
- The depth of the bottom of the excavation must allow a **slope of 2% minimum** on the raw domestic sewage pipe, for the connection between the sewage outlet and the system.
- The bottom of the excavation will be made of stabilized sand (sand 0-4 with cement dosed at 200KG per m³ of sand) with a thickness of 300 mm (1).** This bottom of excavation will **be perfectly leveled** (flatness and horizontality of the bed of installation must be ensured) and carefully compacted to avoid the later settlements. The walls of the excavation shall be at least 300 mm apart from the pipe at all points.

3.4.2. Installation of the device in difficult terrain

- Once the bottom of the excavation has been stabilized, place the tank on the bottom of the excavation, horizontally in the direction of the flow. Make sure that it is well wedged and leveled.
- Connect **the water outlet and air inlet pipes of the filter (2)** in a watertight manner in accordance with the installation instructions.

3.4.3. Peripheral backfill in difficult terrain

- The backfill is carried out in successive layers of 300 mm with stabilized sand (sand 0-4 with cement dosed at 200KG per m³ of sand) (3)** while filling the **primary** treatment tank with clear water (from the beginning of the backfill) in order to balance the pressures.
- This backfill layer should be carefully compacted (mechanical compaction is not

A. INSTALLATION GUIDELINES

allowed) to avoid further settling and deformation of the tanks.

- Repeat the backfilling operation with filling and manual compaction until the wastewater inlet pipe is reached.
- Check that the system is leveled. **Connect the sewage inlet and air outlet pipes (4)** in a watertight manner.
- The ventilation must be carefully made, without any counter-slopes, without 90° PVC bends (preferably using bends less than or equal to 45°) and as straight as possible.

The air extraction pipe from the septic tank must be :

- vertical and independent,
- with a minimum diameter of 100 mm,
- necessarily equipped with an extractor (static or wind) located at least 400 mm above the roof ridge,
- at least 1 meter away from any opening and any other ventilation or any other obstacle.

The minimum distance between the air inlet and outlet must be 1m.

3.4.4 Finalizing the work in difficult terrain

- Place the lids and secure them by tightening the screws on top.
- Continue backfilling with stabilized sand up to 200 mm below the lids (total height of stabilized sand 1800 mm from the bottom of the tank).
- The surface backfill of the devices is made with topsoil (maximum thickness of 200 mm) cleared of all stony or sharp elements to avoid alteration of the covers **(5)**.
- The final backfill must allow all buffers and sealing devices to remain visible and flush with the finished ground level without allowing runoff to enter.
- In addition, it must ensure that the pipes and any extensions are covered with sufficient backfill height to allow for subsequent settling.
- Lids shall not be buried and shall remain accessible for maintenance.

3.5 INSTALLATION UNDER ROADWAY, YARD OR STORAGE AREA

❖ Installation conditions:

- Installation under roadway, yard or storage area
- The installation will be carried out in accordance with the preceding paragraphs, taking into account the nature of the ground.



A concrete distribution slab must be provided for installation under roadways, yards or storage areas.

- A reinforced concrete distribution slab must be built above the treatment plant. It must not rest on the tanks under any circumstances.
- The slab must rest at the periphery on stable supports of undisturbed ground. Otherwise, specific foundations will have to be made.
- These foundations, the thickness of the distribution slab, the installation of the access lids to the primary tank, to the treatment unit and to the sampling manhole, the reinforcement and the structure of the slab in question, the installation methods, etc., will be defined by a qualified engineering office, according to the projected loads and to

A. INSTALLATION GUIDELINES

the nature of the ground in question.

- The access devices to the tank at the level of the distribution slab are not supplied. These lids must be adapted to the applied loads and approved by the design office.
- The layout of the concrete slab must take into account the entire area subject to permanent or temporary rolling loads. Extensions of the air inlet and outlet connections as well as those of the pre-filter (in the primary tank) and the alarm must be provided if necessary. Proper operation of the ventilation system must be ensured and verified.

3.6 OTHER SPECIAL CASES

3.6.1. Works located on sloping ground (>5%), buried installation

According to the nature of the ground, a retaining wall may be necessary to ensure the good holding of the backfill. The thickness and the structure of this retaining wall are to be defined with a specialized engineering office. This same engineering office will also specify the nature and the methods of the backfill.

3.6.2. Buried assimilated installation

It is possible to envisage a buried assimilated installation of the MONOBLOCK V3 by recreating the conditions of a burial in order to respect the structural constraints of the system.

The principle, to be validated by a **specialized engineering office**, is to build a peripheral wall with the same recommendations as those for dry land and a minimal backfill up to the water inlet of the plant. The surface backfill is identical to that applied in dry conditions.

It is essential not to forget to make a special section in the lower part of the wall, to allow for the evacuation of residual water around the tank.

3.7 EXTENSIONS AND COVERS ACCESSORIES

COVERS

- The MONOBLOCK V3 filter has two covers : one with a diameter of 600 mm for the primary treatment and the other with a diameter of 1000 mm for the secondary treatment to allow inspection. They must always remain accessible.
- It is imperative to secure them by tightening the M8 screws on the top of the lid and to check the good position of the seals.
- It is forbidden to stand, walk or stack loads on the covers. These covers have a pictogram mentioning the prohibition to walk on them.

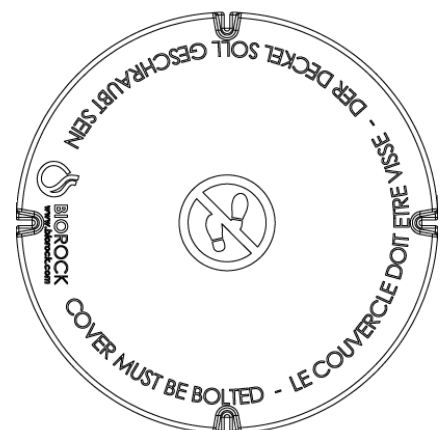

CUT-OUT OR ATTACHED EXTENSIONS

The MONOBLOCK-2 V3 tank includes an integral extension piece, allowing a 450 mm depth of burial. For special applications (see below), a maximum of three 200 mm high extensions can be added.

- **Shallow installation, corresponding to the special case of a backfill height \leq 450 mm:** cutting out the tank-integrated extensions

The tank of the MONOBLOCK-2 V3 device has integrated extensions over a height of 450 mm.



MONOBLOCK-2 V3 tank-integrated extensions

If the tank is to be installed at a shallow depth (\leq 450 mm of backfill), it can be cut to size on site at the level of its integrated extensions. Two cutting levels are possible; the choice of cutting level depends on the backfill height to be achieved on site (see diagram below):

- the first level (N1) lowers the initial tank height by 140 mm (i.e., a height of 1868 mm from the bottom of the tank after cutting)
- the second level (N2) lowers the initial height of the tank by 280 mm (i.e. a height of 1728 mm from the bottom of the tank after cutting)

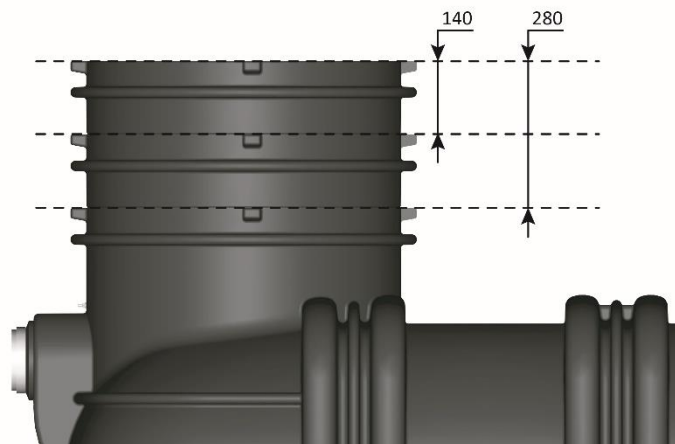

Possible cutting levels for integrated risers
(example of the integrated extension on the DN 600 access to the primary treatment unit)

A. INSTALLATION GUIDELINES

The procedure to be followed is as follows: each element shown below is cut to the same level (140 or 280 mm).

Cutting the distribution tray support rods

- Remove the nilstop nut from each of the 4 threaded rods holding the distribution tray. Set them aside.
- The ring, located in the manhole of the secondary treatment unit, is supported by 3 self-drilling hex-head screws.
- Drill 3 new points in the tank using a 3 mm drill bit. Depending on the backfill height selected, these points can be either 140 mm or 280 mm lower than the initial points. Centering pins are provided to show the correct locations.
- Unscrew the hexagon-head screws and position them in the new holes.
- Use manual pressure to lower the ring onto the new support.
- Shorten the 4 threaded rods by 140 mm or 280 mm, depending on the level of cut selected, using a handsaw.
- Replace the 4 nilstop nuts.

Cutting manholes :

- Unscrew the 4 screws securing the cover and remove it. Set the screws aside.
- Remove the 4 brass inserts in the tank, using an M8 stainless steel hexagonal head screw with nut. Set aside.

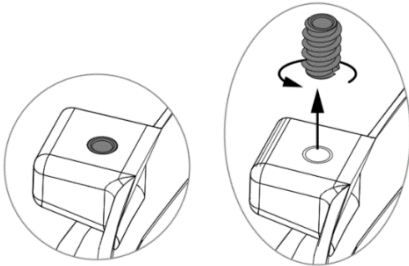

- Make the cutout on one of the two levels; either 140 mm (level N1) or 280 mm (level N2) from the top. The cut-out levels will reveal new lugs for securing the cover. ○

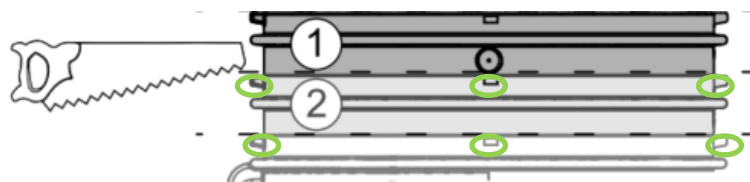

- Drill the 4 lugs with a 10 mm drill bit.

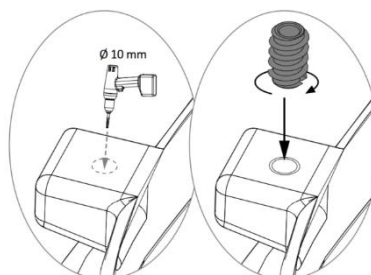

A. INSTALLATION GUIDELINES

- Screw the 4 reserved inserts into the 4 newly created slots.
- Reposition the cover on the manhole. Ensure that the cover gasket is correctly fitted. The gasket ensures a watertight seal.
- Re-tighten the 4 original screws to lock the cover in place.

Cutting the effluent filter :

- Pull the plug (with the effluent filter) and remove the effluent filter from its sleeve.
- Using a handsaw, cut the casing tube at one of two levels: either 140 mm (N1) or 280 mm (N2).
- Shorten the effluent filter rod to the chosen length (140 or 280 mm).
- Replace the effluent filter in its sheath and fit the cap at the end of the tube.

Cutting the alarm :

- Remove the entire IRL (Smooth Rigid Insulation) alarm tube from its sheath.
- Remove the 50-20 reducer from the top of the sheath tube, reserving it for future use.
- Shorten the IRL tube at its lower end on one of the two cutting levels; either to 140 mm (N1) or 280 mm (N2).
- Shorten the smooth sheath tube to the chosen length (140 or 280 mm),
- Replace the 50-20 reducer at the end of the sheath tube,
- Replace the IRL tube in the sheath.

Cutting the ventilation duct (filter) :

- Remove ventilation cap.
- Shorten the ventilation tube; either by 140 mm (N1) or 280 mm (N2),
- Replace ventilation cap.

All operations are carried out by the installer on site.

▪ **Deep installation, corresponding to the special case of a tank backfill height > 450 mm**

It is possible to elevate the MONOBLOCK V3 by adding a **200 mm high polyethylene extension**.

Each extension set (kit) includes the accessories required to raise the effluent filter, the filter aeration and the 200 mm alarm.

When adding more than one extension (up to a maximum of three 200 mm extensions), the operations described below must be repeated as many times as the number of extensions, in order to fit the different kits together.

The accessory kits are composed as follows:

- Effluent filter extension kit

A. INSTALLATION GUIDELINES

- 1 PVC socket pipe - Diameter 110 - Length 275 mm for effective socketing of 200 mm
- 1 Threaded rod - Diameter 6 - Length 200 mm
- 1 Eye nut M6 - stainless A2
- 1 Hexagonal nut - A2 stainless steel
- Alarm extension kit
 - 1 IRL PVC pipe - Diameter 20 - Length 200 mm
 - 1 PVC socket pipe - Diameter 50 - Length 275 mm for effective socketing of 200 mm
- Filter aeration extension kit
 - 1 PVC socket pipe - Diameter 110 - Length 275 mm for an effective socket of 200 Mm

The distribution system is not extended.

All operations are carried out by the installer.

Extension of manholes :

- Unscrew the 4 screws securing the cover and remove it.
- Position the extension on the tank and secure with the screws included in the kit (4 M8 A2 stainless steel screws per kit).
- In the case of two or three sockets: position the top socket on the previous one and repeat the fastening operation from one socket to the next.
- Reposition the cover on the upper socket. Make sure the lid gasket is correctly seated and tighten the 4 original screws to lock the lid in place.

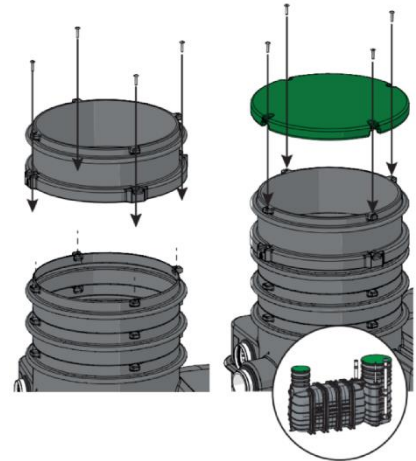

The shape of the parts and the way they fit together ensure a watertight seal between the tank and the socket and socket and socket. Socket-lid sealing is ensured by a gasket on the lid.

Extension of the effluent filter :

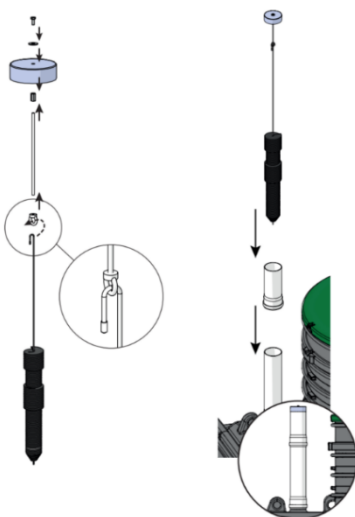

- Pull the plug (with the effluent filter) and remove the pre-filter from its sleeve.
- Unscrew the eye nut located under the cap and screw it onto the kit's threaded rod extension.
- Replace the screw and washer on the cap.
- Screw the long nut onto the screw, then screw the threaded rod onto the bottom of the long nut.
- Fit the extension spigot tube onto the existing sleeve tube.
- Replace the effluent filter in its sleeve and fit the plug onto the end of the tube.

A. INSTALLATION GUIDELINES

Extension of the alarm :

- Remove the entire IRL alarm tube from its sheath,
- Also remove the 50-20 reduction at the top of the sheath tube.
- Place the IRL extension tube, supplied in the kit, at the lower end of the existing long IRL alarm tube.
- Place the extension spigot tube, supplied in the kit, on the existing smooth sheath tube.
- Replace the 50-20 reducer at the end of the sheath tube.
- Insert the raised IRL tube into the sheath.

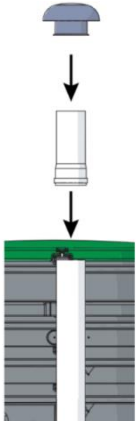
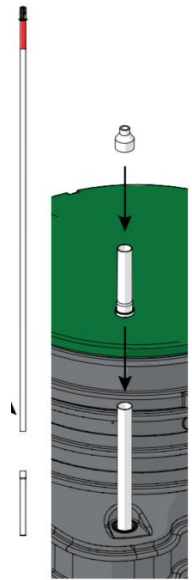

Ventilation extension (filter) :

- Remove the ventilation cap.
- Place the kit's push-fit tube on the existing smooth tube.
- Replace the ventilation cap.



A maximum of 3 extensions can be added, which allows the filter to be buried according to the following diagram.

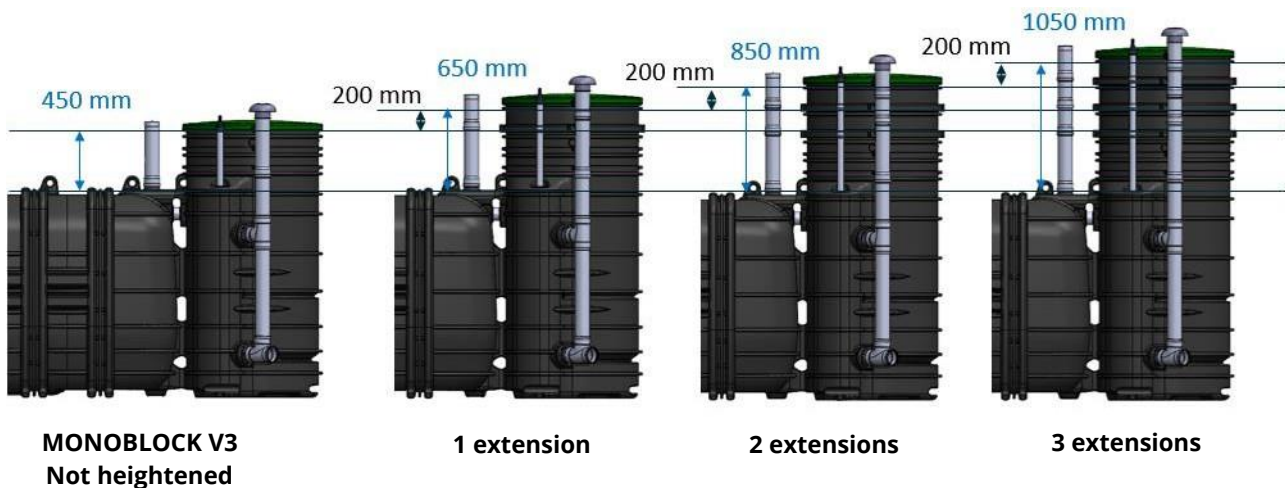

However, the maximum backfill height on the tank roof cannot exceed 450 mm.

Therefore, the installation of the system with the presence of an elevation must be **submitted to a specialized design office** to determine the implementation and installation methods.

If the height of the backfill is greater than the height declared by the manufacturer on the basis of the so-called "Pit-Test" (450 mm), it is possible to create a load distribution slab in reinforced concrete.

A. INSTALLATION GUIDELINES

This slab :

- is positioned at **a maximum of 450 mm from the tank roof**.
- **does not rest on the tank**. The loads on the slab are not transmitted to the tank.
- does not rest on the backfill of the tank body but must only **rest on the external edges of the excavation** made for the installation of the device.
- provides the necessary openings for the different risers (extensions): manholes, ventilation, alarm, pre-filter.

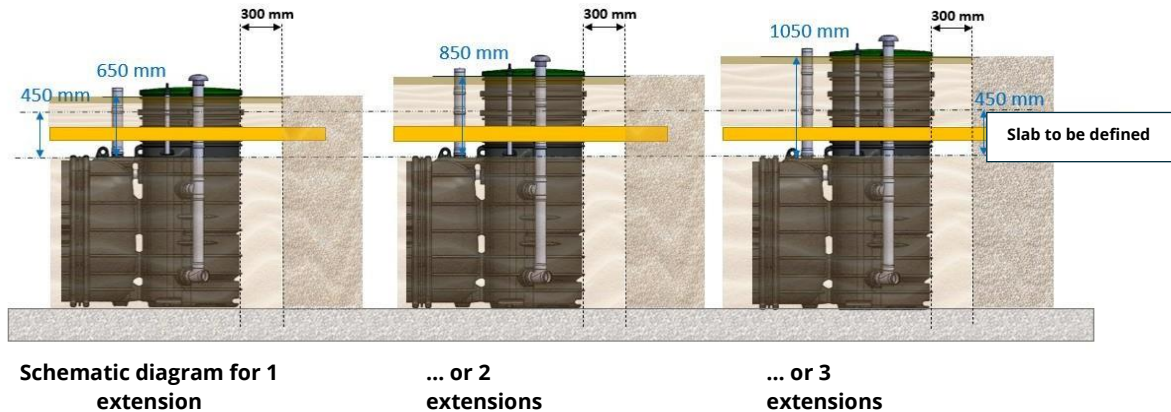

The characteristics of the slab (positioning, reinforcement, dimensions, thickness, etc.) are determined by a design office. Moreover, the accesses are adapted to these loads, i.e. classified lids adapted to the applied loads, all validated by a design office.

4. COMMISSIONING

Once the installation is completed, the commissioning of the system must be carried out as soon as the raw water flows into the primary tank. This operation is carried out by the installer following these steps:

1- CHECKING THE FLOWS

In the presence of sewage, make sure to respect the safety instructions (see §B.1).

- 1.1** Check that the water is flowing correctly into the primary tank. The water level must not exceed the air outlet. The inlet pan must not be obstructed and the prefilter inserted in the outlet pan must be correctly positioned (the upper limit of the brush must be positioned at the water level):

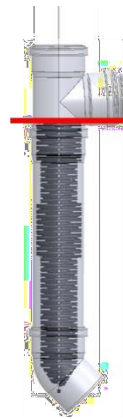

- 1.2** Check that the distribution tray is leveled. Check that the water coming out of the primary tank feeds the tipping tray and that it tilts in both directions equally.

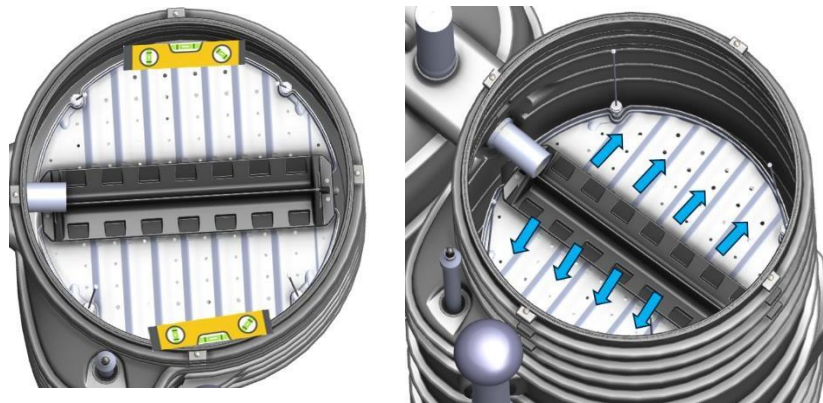

A. INSTALLATION GUIDELINES

- 1.3** If the above two checks are not valid, adjust the level by adjusting the threaded rods holding the tray. There should be no water retention.

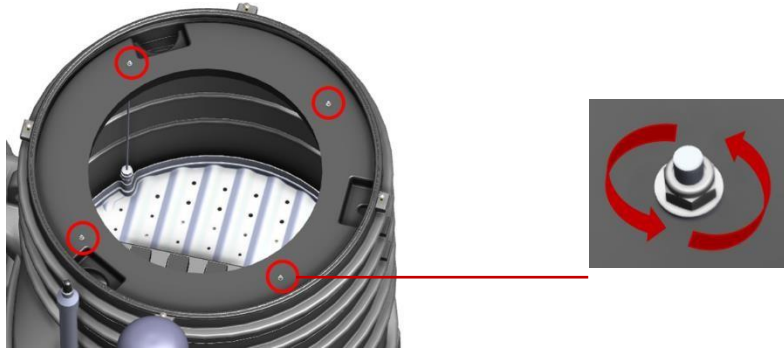

- 1.4** Check the flow of treated water at the outlet of the treatment unit(s) via the sampling manhole, the outfall or the lifting station (supplied as an option).

2- VENTILATION

The primary tank generates gases from the anaerobic decomposition which can present a health risk when exposed to high concentrations (hydrogen sulphide type, methane). These gases must be evacuated by an efficient ventilation in order to avoid any olfactory pollution. Good ventilation is also essential to ensure the supply of oxygen to the treatment unit necessary for the oxidation reactions by the bacteria.

- 2.1** Check that the ventilation of the treatment unit is functional by a **smoke test** ⁽¹⁾.
- 2.2** **No 90° PVC elbows** should be present on the PVC pipe line of the upper ventilation (air outlet). Use elbows less than or equal to 45°. Depending on the surrounding conditions (wind exposure), the installation of the wind exhauster is recommended. The top and bottom vents must be in an open area (tree at more than 3 m). The lower vent is equipped with a vent cap and placed between 150 mm and 500 mm from the ground or free of vegetation and snow. Fermentation gases must be evacuated through the upper ventilation located at least 40 cm above the roof ridge.

A. INSTALLATION GUIDELINES

The height differential between the upper and lower ventilation must always be > 4 m. The distance between the tank and the vertical air extraction pipe is < 15 m.

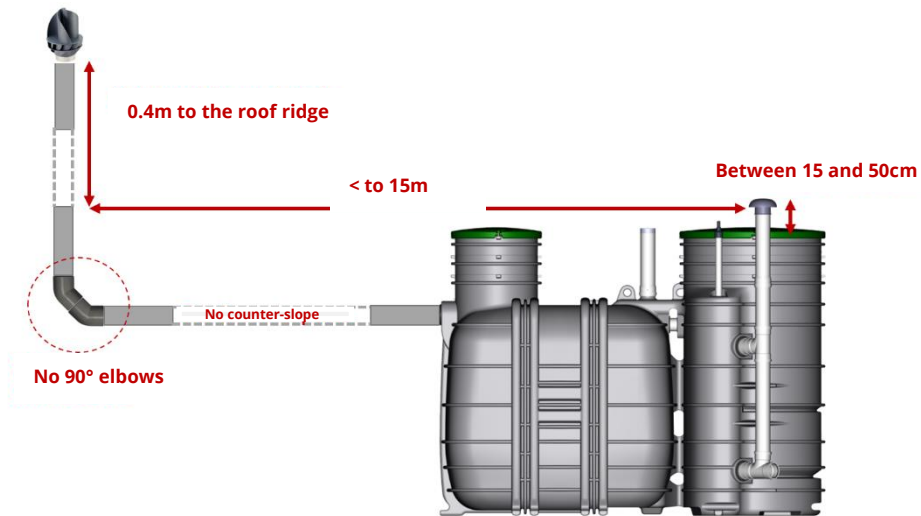

(1) **The smoke test** is a way to check the proper functioning of the ventilation of the primary tank and the treatment unit(s). The test consists of positioning a smoke cartridge at the air inlet (low ventilation) and observing the smoke flow at the ventilation outlet (high ventilation). Within 2-3 minutes, smoke should be observed at the air outlet.



Do not place the smoke cartridge directly on the surface of the system's components (PVC pipe, tipping tray, media, ...). Use a resistant support (ceramic plate, metal cover, glass, ...) to place it on a flat surface (for example on the distribution tray) or use a multi-socket clamp to hold it close to the air inlet ventilation cap. Once the smoke generator is lit, close all the lids to keep the seal.

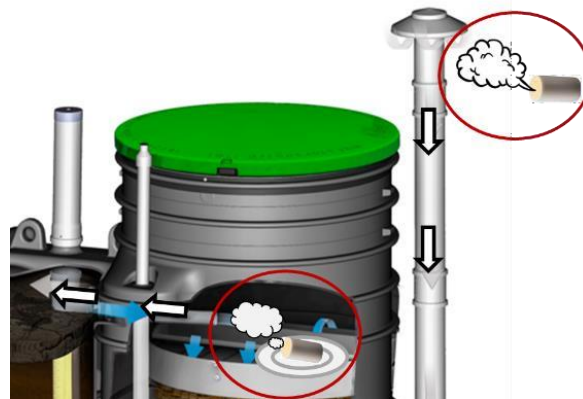

3- ACCESSIBILITY

The accessibility to the system and all the lids must be guaranteed. At the end of the commissioning operation, the lids must be secured.

4- STARTING / STOPPAGE

The start-up period of the installation is at least one week, which corresponds to the period of establishment of the biomass to reach the performance of the installation. For periods of stoppage or non-powering of the installation of less than 6 months, no precautions are required. When the system is restarted, it will restart itself and will not require any particular intervention.

For shutdowns longer than 6 months, it is recommended to perform preventive maintenance (see **SB.3.1**).

If a pumping station (supplied as an option) is installed for the treated water, it is preferable to check its operation and to clean it before the shutdown period

The MONOBLOCK V3 system is perfectly suited for second homes.

5. CONFORMITY OF THE WORKS AND REPORT OF THE END OF THE WORKS

In all cases, the owner and the installer will have to jointly fill in the control form of good installation of the domestic sewage treatment plant (*Appendix 5*) and send it back to the manufacturer whose address is mentioned on the said form.

This document, duly completed and received by BIOROCK®, allows the user to obtain a control visit from the manufacturer. It is available in each MONOBLOCK V3 device at delivery and attached to the User's Guide. It can also be filled out on www.sav.biorock.com.

Once the system has been put into operation, complete the monitoring table indicating the actions taken (*Appendix 4*).

6. WARRANTIES

Conditions of activation and extension of the Manufacturer's Warranty:

Definition of the BIOROCK® warranty:

The equipment and accessories, ex works, are guaranteed to be free from any manufacturing defect. Thus, the BIOROCK® "Manufacturer's Warranty" applies to manufacturing defects and to all the instructions for use defined in this guide.

If it is proven, following a complaint, that the malfunction is due to a misuse of our products, they are not covered by the "Manufacturer's Warranty". In particular, the "Manufacturer's Warranty" cannot be conditioned by a structural defect during the draining operation.

The installer ensures the guarantee of the realization of the installation, he subscribes a ten-year insurance. The decennial guarantee is imposed on the constructors, the manufacturer being subjected in this framework via the EPERS.

In the event of a defect or manufacturing fault recognized by the supplier, the guarantee is limited to the replacement of the defective parts. Defective equipment and accessories will be held at the disposal of the manufacturer and repackaged in their original packaging, if necessary.

The warranty claim cannot be invoked by anyone in case of :

- Non-compliance with the basic dimensioning data of the present sanitation system
- Non-compliance with the installation and use instructions detailed in the Guide;
- Non-compliance with the other requirements of the regulations and standards specified in force;
- Damage caused by any accidental or climatic event beyond our control;

BIOROCK® guarantees :

- **The bacteriological support (BIOROCK® purification media) for a period of 10 years.**
- **The tanks for a period of 25 years.**

Activation of the BIOROCK® "Manufacturer's Warranty"

Within the framework of the activation of the "Manufacturer's Guarantee", BIOROCK® recommends to the owner of the installation to fill in the control form of the good installation of the non collective sanitation system (Appendix 5 "Form prior to the BIOROCK® control visit", in the User's Guide or on www.sav.biorock.com). It is advisable to fill in this form jointly with the installer in charge of the works, and to return it to the address indicated on the document within 120 days after the commissioning.

Upon receipt of the duly completed document, BIOROCK® will schedule a free visit to check the equipment of the installation and to propose a maintenance contract.

Failure to deliver:

In the case of an incomplete delivery (missing equipment or accessories) or of a deterioration noted at the time of delivery, these reservations must be written on the delivery note or the transport slip of the carrier. The carrier and the supplier must be informed by registered letter with acknowledgement of receipt.

Follow the instructions for maintenance and visual checks to keep the system working. If you have any questions, please contact your distributor.

BIOROCK® SARL

4-5 Zone d'Activités Economiques
Le Triangle Vert
L-5691 ELLANGE - Luxembourg

Email : info@biorock.com
Phone : 00 352 26 65 00
26

Name of your distributor:

Contact:

Company stamp:

B

User Guide

MONOBLOCK-2 V3

Capacity up to 600 l/d



TABLE OF CONTENTS

1. SAFETY INSTRUCTIONS	38
2. END-OF-LIFE RECYCLING.....	40
2.1 SEWAGE WASTE	40
2.2 POLYETHYLENE AND PVC	40
2.3 BIOROCK® MEDIA	41
3. MAINTENANCE AND UPKEEP	42
3.1 ANNUAL MAINTENANCE	42
3.2 SPECIAL MAINTENANCE	49
3.3 MALFUNCTIONS	51

1. SAFETY INSTRUCTIONS

Relating to the start-up and operation of the BIOROCK® compact wastewater treatment plants

BIOLOGICAL RISK

• Every day, a person discharges a large quantity of organic and mineral matter into his sewage. This matter contains in particular phosphorus (from detergents), 1 to 10 billion germs per 100 ml and particularly microbial fecal germs (bacteria and pathogenic viruses responsible for sometimes very serious diseases).

The objective of non collective sanitation is to prevent any sanitary risk, to limit the impact of the discharge on the environment and to protect the water resources.

The discharge of treated water into a watercourse allows the natural self-purification of the residual pollution.

Nevertheless, in the sanitation of individual houses, sewage infiltration into the ground should always be sought to avoid the risk of direct contact with even treated sewage.

• **It is imperative to avoid any contact with effluents.** Any direct contact with sewage, even if treated (there is always a residual of pathogenic germs) is to be avoided to prevent any risk of contamination either direct or indirect with other people.



Thus, the personnel working on the site must be equipped with individual protection (waterproof gloves, overalls, protective glasses and safety shoes) and must have disinfectant products available nearby. Even treated wastewater contains microbial fecal germs (bacteria and viruses responsible for sometimes very serious diseases).

In case of accidental contact or injury, for example in case of direct contact with the skin, rinse the affected area thoroughly with drinking water and then apply a disinfectant. Consult your general practitioner for advice.

• **It is strictly forbidden to reuse the treated water as it is for any application representing a risk of direct human contact.**

Treated water can be reused with undirect human contact, subject to local regulations, with or without additional tertiary treatment (not supplied by BIOROCK), for example in underground irrigation.



Indeed, particular attention should be paid to applications where there is a risk of direct human contact (washing, surface irrigation, discharge into a pond or lake, etc.) and for use related to human consumption (vegetable gardening). Tertiary treatment is then required to eliminate the risk of bacteriological contamination.

• It is necessary not to promote the development of mosquito breeding grounds likely to transmit vector-borne diseases, nor to cause an olfactory pollution. The whole device must be hermetically sealed against the penetration of insects. If necessary, the air inlet at ground level must be equipped with an anti-mosquito screen (mesh size 1x1mm). The installation must not have any water stagnation areas. Take care to maintain the outlet of treated water (ditch) in order not to favor the development of breeding grounds.





B. USER GUIDE



CHEMICAL RISK

- ◆ Never smoke near the tanks during the operations described in this manual.
- ◆ Never open the lids, without having taken all the safety measures beforehand (atmosphere control device, breathing apparatus, degassing of the tanks, etc.). The biological reactions that take place in the primary tank (fermentation) produce gases (in particular hydrogen sulphide H₂S and methane CH₄) that can be toxic in high concentrations (in the case where the ventilation of the system is not functional). 
- ◆ For the reasons explained above, it is forbidden to enter the tanks.

PHYSICAL RISK

- ◆ Except for the presence of a pumping station downstream (supplied as an option), the MONOBLOCK-2 V3 system does not require any source of energy (consumption of the reference model MONOBLOCK-3-1000 V3 tested in a treatment efficiency test = 0 kWh/d) and does not generate any noise (declared sound level of 0 dB). Thus, the MONOBLOCK-2 V3 treatment systems do not require any external energy source and avoid any noise pollution.
- ◆ When the presence of a pumping station (supplied as an option) is necessary for the evacuation of the outlet water, the interventions on the electromechanical equipment (pump, control panel) will have to be carried out by a qualified professional according to the prescriptions of the regulation in effect and in particular of the IEC 60364 standard. 
- ◆ When handling the tank, make sure that the tanks are properly slung by the rings placed at the top. Make sure that no one is in the maneuvering areas, do not stand under the load. 

MECHANICAL RISK

- ◆ The installation must have a permanent visual boundary (border, fence, stonework, etc.).
- ◆ It is forbidden to drive or park within 3 meters of the tanks' perimeter. 
- ◆ Access to the manholes and covers of the system is mandatory for maintenance operations, both for the lid of the primary tank and for the treatment unit. It is forbidden to leave any load on the lids.
- ◆ The manhole covers are secured with screws, make sure that the screws are always kept tight for the safety of all.
- ◆ Never leave manhole lids unattended when working on them. The lids must be closed again after any intervention.
- ◆ Do not walk, stand or stack loads on the lid. 

2. END-OF-LIFE RECYCLING

BIOROCK® has developed a non collective sanitation process that does not use any energy source to operate; the natural biological reaction does not require any chemical product.

The owner and the user of the MONOBLOCK V3 non collective sanitation units follow the logic of this approach by implementing the control actions and by calling upon the professionals of the sanitation sector to carry out the interventions necessary for the good functioning of the installation.

The accessories and materials used in the manufacture and assembly of MONOBLOCK V3 installations are not subject to corrosion.

BIOROCK® declares that the thick HDPE (High Density Polyethylene) rotational molded tank has a life span of at least 30 years and is 100% recyclable. The screws and bolts are made of A2 stainless steel, the piping is made of PVC or HDPE commercial sewage pipe. The whole installation is at least 98% recyclable.

2.1 SEWAGE WASTE

It results from the operation of the purification systems and the maintenance of the wastewater disposal networks. It is mainly organic waste (sludge, grease, waste from the screening of wastewater treatment plants, wastewater disposal material, etc.) or mineral waste (sand from wastewater treatment plants, sludge, sand from the cleaning of sanitation networks, residues from the dredging of waterways, etc.).

The sludge generated in the primary tank will have to be periodically emptied: an approved service provider will carry out the emptying and will take care of the elimination of the extracted matters of the ANC installation.

The BIOROCK® media at the end of its life can be taken in charge by BIOROCK® and/or by a service provider and be directed towards a specialized treatment channel such as the recycling of rock wool, the treatment on a composting platform (horticultural waste) and the energetic valorization in accordance with the regulations in force.

The used prefilter at the end of its life will be put in a waste disposal center (all waste) after rinsing.

2.2 POLYETHYLENE AND PVC

Polyethylene and PVC parts should be disposed of in a waste disposal center so that they can be recycled according to certain processes:

2.2.1. Energy recovery

Plastics have a high calorific value which can be equivalent to that of fuel or coal (PE, PP). They can therefore be incinerated with energy recovery.

This recovery is more particularly indicated for soiled or mixed plastics but can present some disadvantages:

B. USER GUIDE

The calorific value of plastics can become a disadvantage in case of thermal overload of the incineration furnaces.

The incineration of plastics can generate pollutants in the fumes (hydrochloric acid).

2.2.2. Material recovery

Regeneration consists in transforming plastic waste of the same nature (PVC, PE) into granules or powder to be marketed as a substitute for virgin resins. Recycling consists of molding a finished product directly after grinding and remelting. Chemical recovery consists of breaking down the macromolecules that make up the polymers into reusable raw materials.

2.3 BIOROCK® MEDIA

BIOROCK® media is a recyclable mineral product made from volcanic rocks.

The BIOROCK® media waste is inert but, in the case of individual sanitation installations, when the BIOROCK® media of the treatment unit is replaced, it means that it is soiled by sludge and it is necessary, in the same way as the sludge during the emptying of the primary tank, to entrust its management to a specialized company.

3. MAINTENANCE AND UPKEEP

The user is responsible for the maintenance of his sanitation system according to the instructions of this guide.

The maintenance logbook in appendix 4 must be correctly filled in by the user or the professional.

3.1 ANNUAL MAINTENANCE

Within the framework of the MONOBLOCK V3 system, the various annual maintenance tasks described below are to be carried out by a professional and/or the user if the latter has the appropriate equipment to carry them out and avoid any health risk. To maintain the long-lasting performance of the device, the maintenance and usage recommendations must be followed regularly.

For a reminder of the safety instructions, see **SB.1**

1- General visual inspection of the system

- The system must be easily accessible.
- All lids must be clear and accessible without any load on them.
- **Check the flow over the whole system:**
 - ✓ After opening all the lids, check that the raw water is flowing through the system (*flush the toilet several times or let a tap run for a few minutes*)
 - ✓ Check the flow at the level of the PVC outlet of the primary tank. Check that the prefilter is correctly positioned (**see SA 4.1 point 1.1**)
 - ✓ Check that the inlet pipe feeds the tipping tray and that it swings in both directions (in SA 4.1 point 1.4)
 - ✓ Check the flow of treated water out of the treatment unit via the sampling manhole, the outlet or the pumping station (supplied as an option).

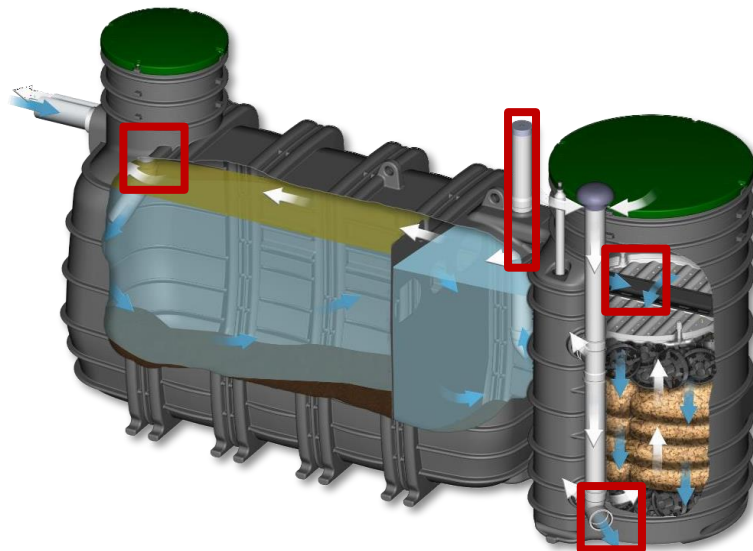

Control points to check the flow of water on a MONOBLOCK V3 system

- Check the tightness of the PVC pipes at the level of the sewage inlet and the supply to the treatment unit.

2- Sewage sampling at the outlet of the primary tank

- Check (visually) the quality of the sewage from the primary tank.
- Take a sample of water from the outlet of the primary tank (directly at the level of the supply pipe of the treatment unit) in a clean glass container (*reminder of the safety instructions §1 for an intervention with sewage*).
- The water should be light brown, brown or yellow in color, turbid to very turbid, but few deposits should be visible at the bottom of the glass after letting the sample stand for 20 minutes. The sampled sewage may have a slight nauseating odor (septic).

3- Measuring the height of sludge in the primary tank

The measurement of the sludge is necessary to calculate the precise height of the sludge in the tank in order to monitor its evolution in relation to the draining threshold. The tool used for the measurement is a **PVC sludge pipe** with a metric scale and a non-return valve. (*See §B.1 for safety instructions when working with wastewater*). As a guide, the frequency of draining should refer to the frequency determined during the purification efficiency tests of the system (see below).

- Assemble the parts of the sludge channel at the junctions
- Plunge the pipe at the entrance of the Primary Tank (the pipe must be plunged first on the side with the flap valve)
- Once the bottom of the tank is reached, raise the sludge rod
- Let it settle for 20 minutes and note the height of the sludge

B. USER GUIDE

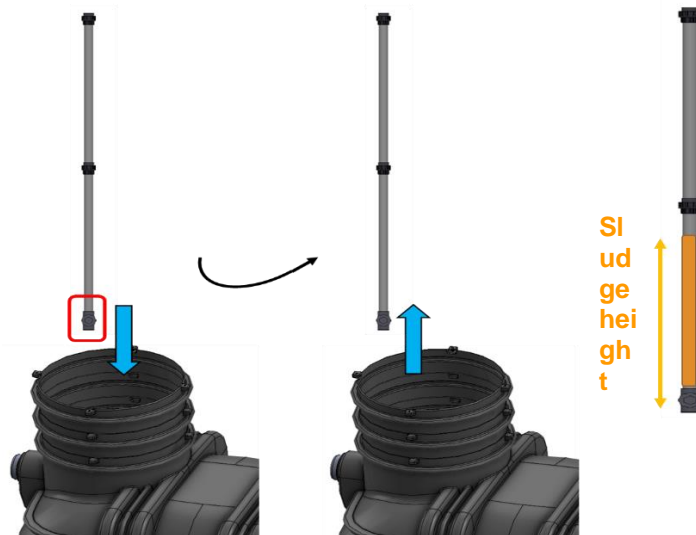

The draining must be done when the sludge level reaches **50%** of the useful volume of the tank. The maximum height of sludge allowed from the bottom of the tank is **72 cm** (with a tolerance of 5 cm) for the MONOBLOCK-2 V3.

Call in an approved emptying contractor to carry out the draining operation from the opening at the head of the primary tank (the compartment closest to the raw water inlet). If there is a decompression well, check that there is no water in the well before emptying the primary tank. If water is present, pump it out using a pump.

A draining slip must be given by the drainer and kept by the user. The elimination of the waste and sanitation by-products must be carried out in accordance with the regulations, in particular those envisaged by the departmental plans for the collection and treatment of waste.

It is advisable during these operations, to make clean the walls of the primary tank with the jet of water under pressure by the approved drainer, to eliminate greases and matters which would have accumulated there. The water jetting machine must be more than 3 m away from the tank.

The tank must be immediately put back in water by the approved drainer.

The quantities of sludge produced are influenced by the use of the system (dimensioning, occupancy rate, frequent overloading, nature of the effluents, routine maintenance). Each system has its own specificities.

The annual sludge production of the primary treatment chamber, measured during the treatment efficiency type tests on the MONOBLOCK-3-1000 V3 platform, was 0.19 m³/year/PE.

CAPACITY	4 PE
ESTIMATED EMPTYING FREQUENCY	13 months

B. USER GUIDE

Checking the sludge level at the time of maintenance allows you to know exactly when to plan the draining.

The frequency observed in situ may be lower than the emptying frequency obtained from the tests, as actual occupancy rates in the home are often lower than the occupancy rates for which the calculated emptying frequency was determined (at full capacity).

Nevertheless, the time between 2 emptying operations must not exceed 2 times the theoretical emptying frequency, **i.e. 26 months**.

When draining, **the drainer must leave a few centimeters of sludge** at the bottom to preserve a part of the bacterial population essential to the anaerobic fermentation.

4- Cleaning the Prefilter of the primary tank

- Open the DN110 plug at the level of the water outlet of the tank allowing access to the prefilter (*see §1 for safety instructions when working with sewage*)

- Take hold of the rod holding the prefilter and gently pull it up to remove it

Clean the prefilter with a jet of water above the manhole at the level of the water inlet in the primary tank

- Put the prefilter back into the PVC tube, and make sure to keep it in its initial position



5. Sewage sampling at the outlet of the treatment unit

- Visually check the quality of the treated water (*if the flow is not sufficient, it may be necessary to flush the toilet to provoke a flow*)
- As part of the monitoring of the purification performance of the system, a 24-hour assessment of the treated water at the end of the system is recommended. The sampling can be done via a sampling manhole (supplied as an option), directly in a pumping station (supplied as an option) if present or at the effluent outlet when accessibility is possible by using a covered buffer tank (minimum dimensions 30*30*H20 cm) (see §1 for safety instructions when working with sewage)

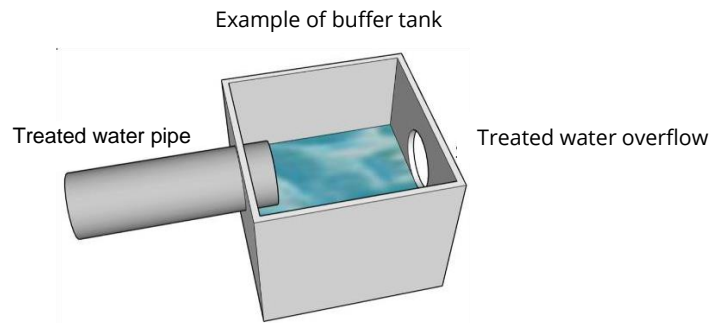

- Use a sampling tool with a telescopic handle or a flexible hose connected to a water pump on a screwdriver, and carry out the sampling. It is important to take the sample at mid-height (not at the surface or at the bottom) and not to stir the water when the sample is taken in a manhole, a pumping station (supplied as an option) or a buffer tank (supplied as an option).
- After allowing the sample to stand for 20 minutes, the water should be clear with very little visible deposit at the bottom. The water should not have a septic or foul odor. It may have a characteristic odor of fresh humus.
- The above mentioned cases allow the collection of a representative sample of the quality of the treatment of the installation; a 24 hours assessment can be done by using an automatic sampler whose strainer is positioned at the middle of the water mass (not at the surface nor at the bottom)

6. Visual control and verification of the alarm operation

During operation, the alarm indicator is in the low position at ground level. In case of problem, the rise in level causes the float to rise, a red light appears.

- Lift the alarm slightly and let it fall back down by itself to check its operation. There should be no resistance.

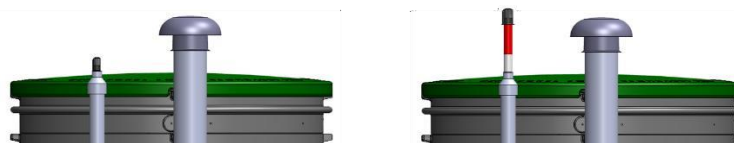

7. Checking and adjusting the distribution system of the treatment unit

If the flow is not sufficient, it may be necessary to flush the toilet to increase the flow.

- Visually check the tightness of the pre-treated water inlet
- Check that the water coming out of the primary tank is flowing correctly into the tipping tray and that the tipping tray is tilting evenly in both directions and check that the distribution tray is level (see **SA 4.1.2**). Clean the tipping tray assembly if necessary (if there is visible dirt).

B. USER GUIDE

- If the above two checks are not valid, adjust the level by adjusting the threaded rods of the tray (see **SA 4.1.3**). No accumulation of water should be observed.
- Check the flow of treated water at the outlet of the treatment unit via the sampling manhole, the outlet or the lifting station.

8. Visual control of the filtering media

- Visually check the condition of the plastic media on the surface
- No water stagnation or dense clogging should be observed on the surface (good flow through the media)
- If stagnation or clogging is observed, remove a few plastic rings (see §B.1 for safety instructions when working with sewage) to observe the underlying media (BIOROCK® media). The media should not be clogged or plugged.



Left: Plastic media. Right: BIOROCK media (underneath the plastic media layer)

Be sure to note your observations on the maintenance logbook (Appendix 4).
In case of clogging, settling or stagnation, contact the BIOROCK After Sales Service (<https://sav.biorock.com/>).

9. Check that the ventilation system is working properly

Follow the procedure described in point 2 of commissioning **SA 4.2**

10. Closing of the lids

Ensure that the lids are tightly closed and secured. Make sure that the lids remain accessible for future maintenance operations.



Once the maintenance is complete, fill in the maintenance logbook (Appendix 4). Indicate all dated operations that have been performed (maintenance operation, draining, remark/comment on the operation...).

3.2 SPECIAL MAINTENANCE

1. Replacement of the BIOROCK® media

We recommend to change the BIOROCK® media if necessary and to clean the treatment tank. When the media is completely clogged, it must be replaced.

Replacement may also be necessary if it has been damaged by non-recommended products discharged into the wastewater system or if it is clogged.



For any intervention with possible contact with Sewage, refer to the safety instructions, cf §B.1

1. Open the lid of the Treatment unit by untightening the M8 safety screws.
2. Unclip the tipping tray, remove the two parts of the distribution tray. The central pipe of the PVC support frame must also be removed.
3. Remove the top layer of plastic rings and store them separately. **For handling the media, use a metal hook to hold the bags.**
4. Remove the middle layer of BIOROCK® media. Also, use the metal hook to hang the net that conditions the media.
5. Remove the bottom layer of plastic rings and store them separately.
6. Wash the bottom and sides of the unit with a water jet.
7. Hose down all plastic rings (open the Primary tank inlet lid and clean the rings above the opening). If the plastic media is damaged, contact the BIOROCK® Service Center to have it replaced.
8. Dispose of the BIOROCK® media bags. **BIOROCK® media should be treated as mineral substrate waste and disposed of by a licensed company.**
9. Replace the bottom layer of plastic media, the middle layer of **new** BIOROCK® media, and the top layer of plastic media **as shown below in their original locations:**

	Top Layer Plastic Rings	BIOROCK® Intermediate Layer	Bottom Layer Plastic Rings
MONOBLOCK-2 V3	1 layer of 200 mm	600 mm layer of BIOROCK® Media	1 layer of 300 mm

B. USER GUIDE

- When placing the bags, make sure that each layer of bags covers the entire surface of the unit, leaving no gaps between them.
- 10.** Replace the center pipe of the PVC support frame and the two parts of the distribution tray. Reclip the tipping tray.
- 11.** Make sure to check the level of the distribution tray and check the water distribution (see point 1-Checking the flow **SA 4.1**)
- 12.** Make sure that the lids are locked at the end of the operation.

2. Replacing the Effluent filter

The Effluent filter must be replaced if the brush bristles are crushed in the center or damaged, making the filtration defective.

- Make sure to wear personal protective equipment. Open the DN110 plug to gain access to the Effluent filter and open the lid of the primary tank.
- Grasp the rod holding the used Effluent filter in the PVC tube and gently pull it out. Rinse it with a jet of water while holding it above the manhole of the Primary tank to remove any solid particles.
- Put the new Effluent filter back into the PVC pipe, and make sure to keep it in its optimal position, with the top of the brush at water level (see A1 point 1).

3.3 MALFUNCTIONS

The performance of the MONOBLOCK V3 system is guaranteed under normal conditions of use, maintenance and upkeep, in accordance with the provisions of this guide: the concentrations at the end of treatment are less than or equal to 30 mg/l for suspended solids (SS), and less than or equal to 35 mg/l for BOD5.

We recommend in all cases to call a professional for maintenance work and for any intervention to be carried out on the non collective sanitation equipment.

In case of failure of the device, the user must call a professional.

The tables below allow to determine the possible causes of the dysfunction. It is possible to contact our after-sales service (sav.biorock.com / aftersales@biorock.com), the installer or the distributor of the system.

Indicate on the maintenance logbook any action carried out on the system (Appendix 4).



For any intervention with a possible contact with Sewage, refer to the safety instructions, see §B.1

3.3.1. PRIMARY TANK

Odour Nuisance	
Possibles causes	Actions
<ul style="list-style-type: none"> ♦ Leakage of the ventilation system. ♦ Leakage of the Sewage network from the discharge points (sink, WC, baths, showers, various siphons, etc.) to the Primary tank. ♦ Leakage of the system's lids or other equipment installed (grease trap, lifting station) ♦ Insufficient ventilation (ventilation pipe with a diameter < 100 mm, bad positioning of the extractor, presence of 90° elbow, etc.) ♦ Strong restriction of the air ventilation in the tank itself, by the presence of a too thick cap (grease and floats) for example. 	<p>Contact your installer or maintenance operator</p> <ul style="list-style-type: none"> ♦ Check if there are leaks in the ventilation and sewage system upstream of the Primary tank. ♦ Check that the lids are closed and not damaged. ♦ Check the presence of seals on the lids. ♦ Carry out a smoke test ♦ Measure the level of sludge (also measure the height of grease and floats on the surface)
Different appearance and/or presence of suspended solids in the pretreated Sewage wastewater	
<ul style="list-style-type: none"> ♦ Hydraulic overload: too much water flow through the structure ♦ Under-sizing of the Primary tank in relation to its regular use. ♦ Abnormal discharge of noxious, toxic or bactericidal products ♦ Maximum sludge height exceeded 	<p>Contact your installer or maintenance operator</p> <ul style="list-style-type: none"> ♦ Check that no rainwater network is connected to the installation. ♦ Check that surface water does not get into the system ♦ Check that the water consumption is equal or lower than the daily flow rate designed for the

B. USER GUIDE

<p>Maintenance of the system not carried out (minimum frequency of once a year)</p>	<p>system</p> <ul style="list-style-type: none"> ◆ If a grease trap (supplied as an option) is installed upstream, check that it is sized according to the rules of the trade, that its maintenance is respected and that its emptying is done regularly according to the use <p>Call on an approved drainer to empty the Primary tank if necessary</p>
<p>Rise of water towards the building</p>	
<p>Clogging at the inlet of the Primary tank (no or little flow of raw Sewage at the inlet)</p>	<p>Contact your installer or maintenance operator</p> <ul style="list-style-type: none"> ◆ Open the lid to have access to the Sewage inlet. ◆ Check if the inlet is clogged. ◆ Rinse, if necessary, with a water jet. ◆ If there is no flow after cleaning the inlet cap, contact a company specialized in unblocking for a camera inspection and a complete cleaning of the raw Sewage inlet pipe
<p>Effluent filter clogged Effluent filter not working</p> <ul style="list-style-type: none"> ◆ Bristles of the brush are crushed in the center or damaged ◆ Broken holding rod 	<p>Cleaning of the Effluent filter (see 4-Cleaning of the Primary tank SB 3.1.4)</p> <p>Change the Effluent filter (4-Cleaning the Primary tank Effluent filter SB 3.1.4)</p> <ul style="list-style-type: none"> ◆ Open the DN110 plug to have access to the Effluent filter ◆ Grasp the rod holding the Effluent filter in the PVC tube and gently pull it out ◆ Put the new Effluent filter back into the PVC pipe, and make sure to keep it in its initial position <p>In case it has been found that the holding rod is broken, check the ventilation of the die (see 2-Ventilation SA 4.2). The gases released by the fermentation reactions in the pit can accumulate in high concentrations due to lack of functional ventilation and corrode the rod.</p>

3.3.2. TREATMENT UNIT

Odour Nuisance	
Possibles causes	Actions
<ul style="list-style-type: none"> ◆ Malfunction of the Primary tank (see table above 3.4.1 Primary tank) ◆ Insufficient ventilation (ventilation pipe with a diameter < 100 mm, bad positioning of the extractor, presence of a 90° elbow, insufficient height differential between the upper and lower ventilation, air inlet not cleared etc.) ◆ Malfunction of the Treatment units filter caused by hydraulic overload or pollution overload ◆ Abnormal discharge of noxious, toxic or bactericidal products, not biodegradable in the installation ◆ Annual maintenance not carried out 	<p>Contact your installer or maintenance operator</p> <ul style="list-style-type: none"> ◆ Check the correct operation of the Primary tank (see table above 3.4.1 Primary tank) ◆ Check the correct operation of the ventilation (see 2-Ventilation SA 4.2) ◆ Check the state of the media (see 8-Visual control of the media condition SB 3.1.8)
Different appearance and/or presence of suspended solids in the treated Sewage	
<ul style="list-style-type: none"> ◆ A hydraulic or organic overload (one-off or permanent) on the treatment system ◆ Abnormal discharge of noxious, toxic or bactericidal products, non-biodegradable in the installation (see good practice sheet) ◆ Repeated malfunctions of the Primary tank (late emptying, sludge discharge, etc.) can lead to the saturation of the Treatment units with deposits or suspended matter. ◆ A non-functional ventilation ◆ A bad distribution of the pre-treated effluents by the tipping tray and the distribution plate ◆ A lifting station installed (supplied as an option) that is not adapted or not maintained ◆ Annual maintenance not carried out 	<p>Contact your installer or maintenance operator</p> <ul style="list-style-type: none"> ◆ Check the correct operation of the ventilation (see 2-Ventilation SA 4.2) ◆ Check the distribution through the tipping tray and the distribution tray in the Treatment units (see 1-Checking the flows SA 4.1) ◆ Check the condition of the media (see 8-Visual check of the media condition SB 3.1.8) ◆ If a pump is installed (supplied as an option) downstream, check that the pump capacity matches the maximum raw water flow rate. Check that the pump is working properly. Change it if necessary.
Water stagnation	
<p>If a significant stagnation of water is observed in the BIOROCK® media:</p> <ul style="list-style-type: none"> ◆ A hydraulic or organic overload (punctual or permanent) on the treatment system ◆ Abnormal discharge of harmful, toxic or bactericidal products, non biodegradable in the installation ◆ Repeated malfunctions of the Primary tank (late emptying, sludge discharge, etc.) can lead to the saturation of the Treatment units with deposits or suspended matter. ◆ A non-functional ventilation ◆ A bad distribution of the pretreated effluents by the tipping tray and the distribution tray ◆ Annual maintenance not carried out 	<p>Contact your installer or maintenance operator</p> <ul style="list-style-type: none"> ◆ Check the correct operation of the Primary tank (see table above 3.4.1 Primary tank) ◆ Check the correct operation of the ventilation (see 2-Ventilation SA 4.2) ◆ Check the flow in the Treatment units especially the distribution system

Clogging and Settling of the media	
<p>The BIOROCK® media can clog and settle progressively in case of malfunction:</p> <ul style="list-style-type: none"> ◆ A hydraulic or organic overload (punctual or permanent) on the treatment system ◆ Abnormal discharge of noxious, toxic or bactericidal products, non-biodegradable in the installation ◆ Repeated malfunctions of the Primary tank (late emptying, sludge discharge, etc.) can lead to the saturation of the Treatment units with deposits or suspended matter. ◆ A non-functional ventilation ◆ A bad distribution of the pre-treated effluents ◆ by the tipping tray and the distribution tray ◆ Annual maintenance not carried out 	<p>Contact your installer or maintenance operator</p> <ul style="list-style-type: none"> ◆ Check the correct operation of the Primary tank (see table above 3.4.1 Primary tank) ◆ Check that the ventilation is working properly (see 2-Ventilation 5A 4.2) ◆ Check the flow in the Treatment units, especially the distribution by the dispersers ◆ Check the condition of the media (see 8-Visual check of the media condition 5B 3.1.8) ◆ If the observation shows that the plastic media is clogged (totally or partially), proceed to its cleaning (see 5B 3.1., steps 1,2,3 and 7 as well as 5B 3.3.1 Replacement of the Biorock® media). ◆ If the report shows that the Biorock media is degraded (deteriorated structure for example), proceed to its replacement (Replacement of the Biorock® media 5B 3.3.1)
Triggering of the visual alarm	
<ul style="list-style-type: none"> ◆ Clogging of the device downstream of the Treatment units ◆ Non respect of the installation conditions of the Treatment units according to the typology of the ground (leading to cracking/deformation of the tank, ...) ◆ Rise of water in the outlet (ditch, river, ...) ◆ Blocked, clogged or broken discharge pipe ◆ Malfunction on the lifting station (supplied as an option) installed downstream of the system (pump out of order, non-return valve or float not working) ◆ A lifting station (supplied as an option) downstream of the system not adapted or not maintained 	<p>Contact your installer or maintenance operator</p> <ul style="list-style-type: none"> ◆ Check that the water table does not exceed the water level of the Treatment units (see Appendix 2 Technical Data Sheets) ◆ Check that the pump installed downstream (supplied as an option) corresponds to the inlet hydraulic flow and to the discharge height/length necessary to reach the outlet ◆ Check the operation of the pump. Replace the lift pump or the float if necessary ◆ Unblock the non-return valve ◆ Check the flow at the point of discharge of the treated water (rise of the water in the ditch or the receiving drain, etc.) and the condition of the discharge pipe (obstruction, clogging, etc.).

C

Appendices

Appendix 1

- 1.1 Plan for the installation and maintenance of the wastewater treatment plant - Installation on dry ground.....56
- 1.2 Plan for the installation and maintenance of the wastewater treatment plant - Installation on wet ground.....56

Appendix 2 MONOBLOCK-2 V3 system layout.....57

Appendix 3

- 3.1 Details of the media layers.....58
- 3.2 Hydraulic and aeraulic flow diagram of the system.....58

Appendix 4 Maintenance and monitoring to be completed by the user.....59

Appendix 5 Activation of Warranty.....60

Appendix 6 Good practices.....61

MONOBLOCK-2 V3

APPENDIX 1.1

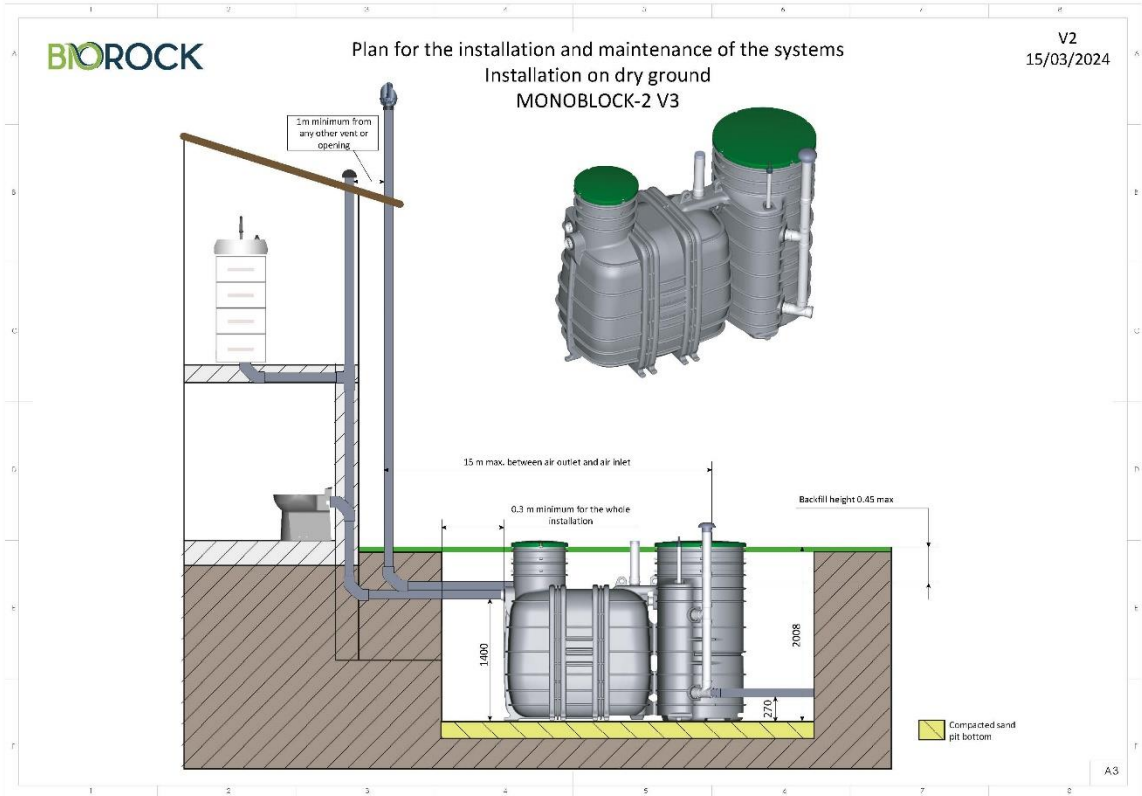

APPENDIX 1.2

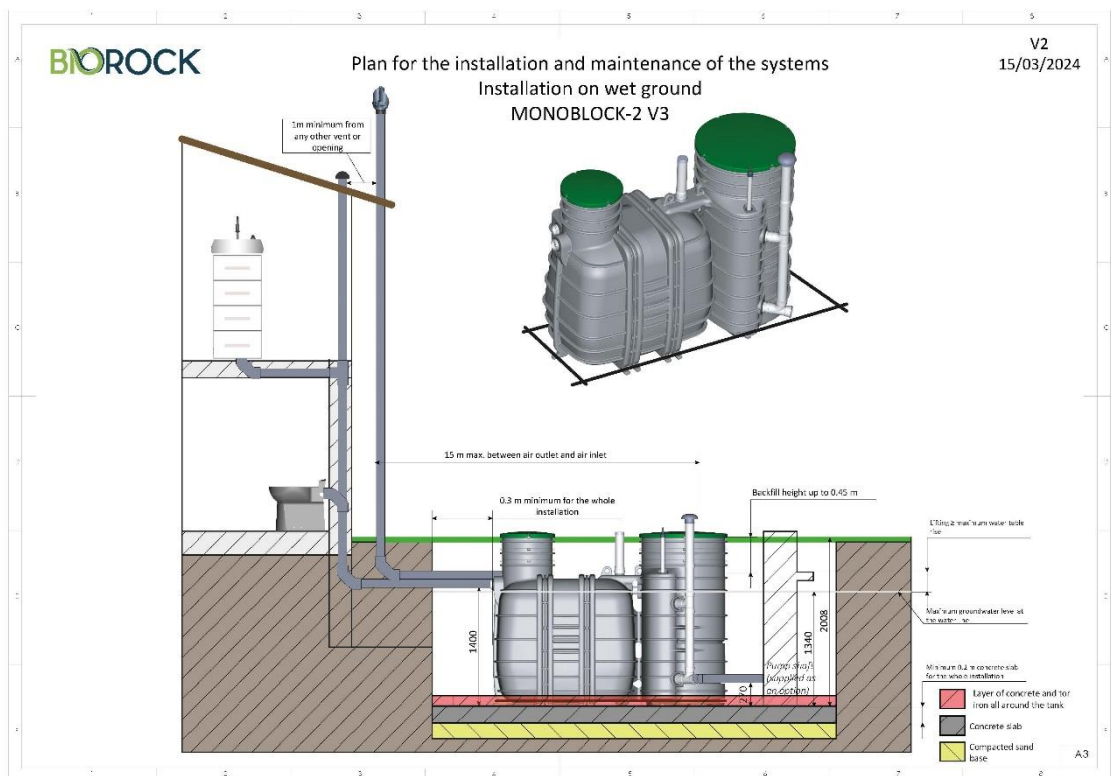

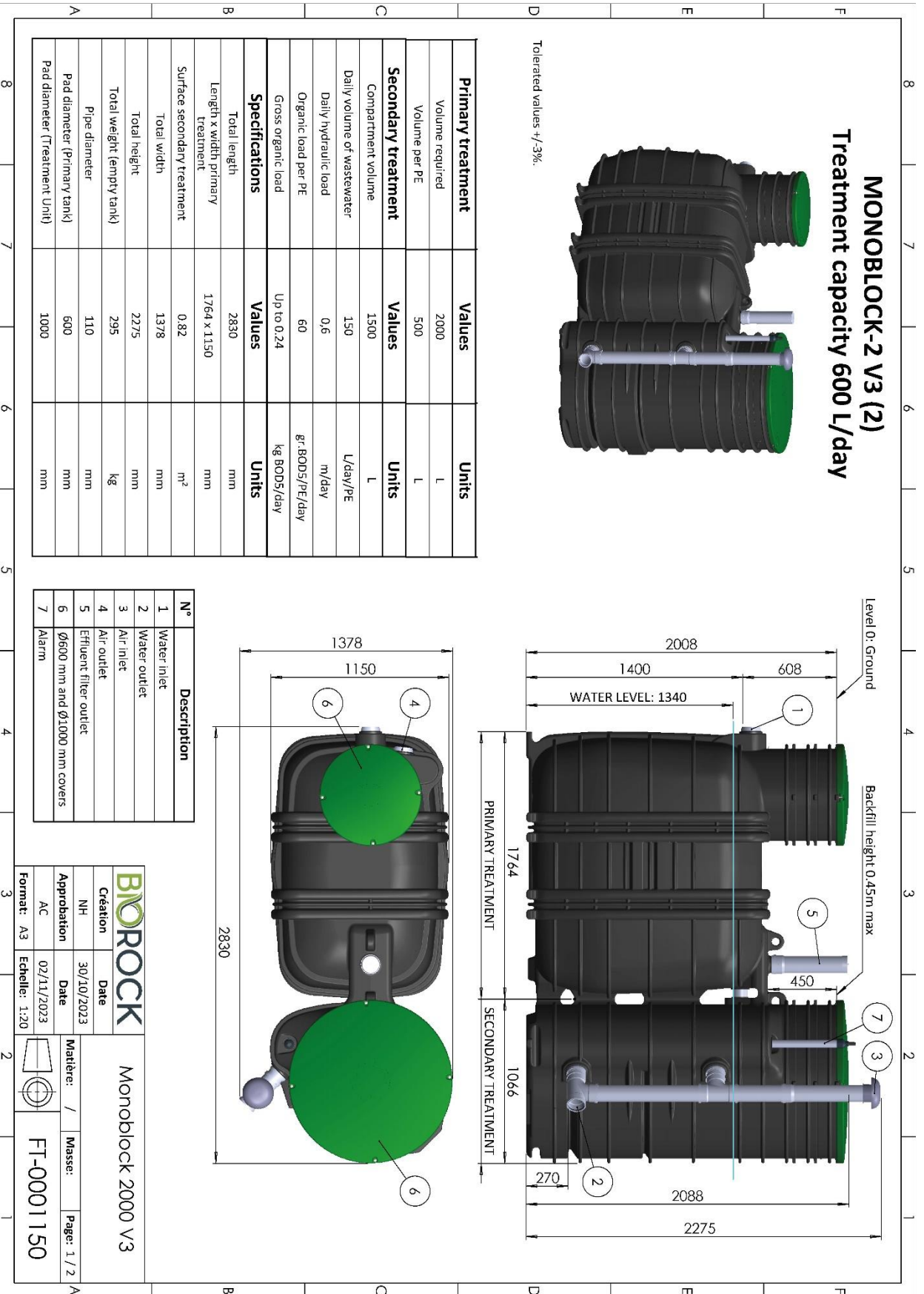

**APPENDIX
3.1**

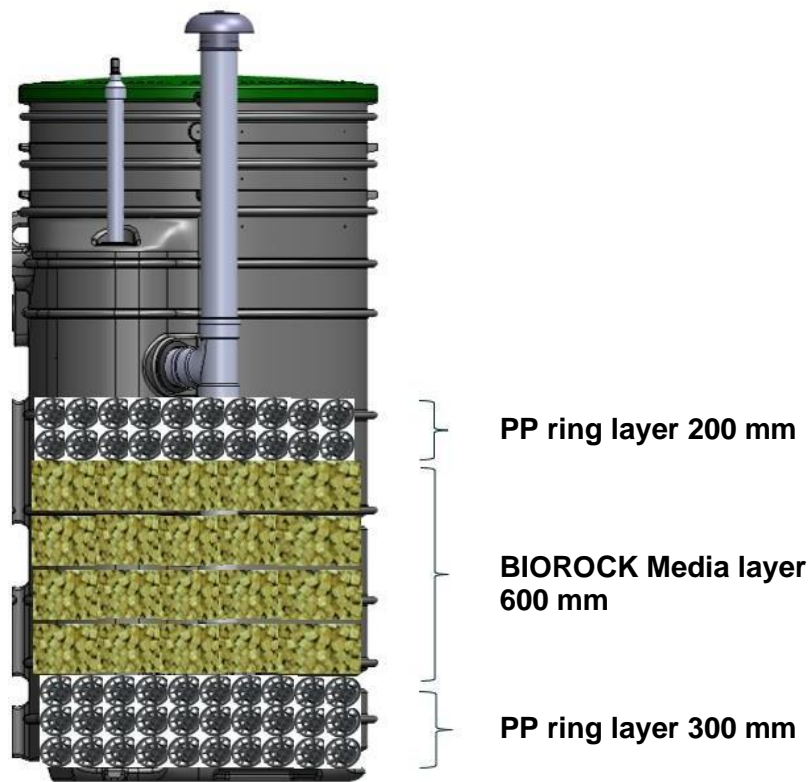

**APPENDIX
3.2**

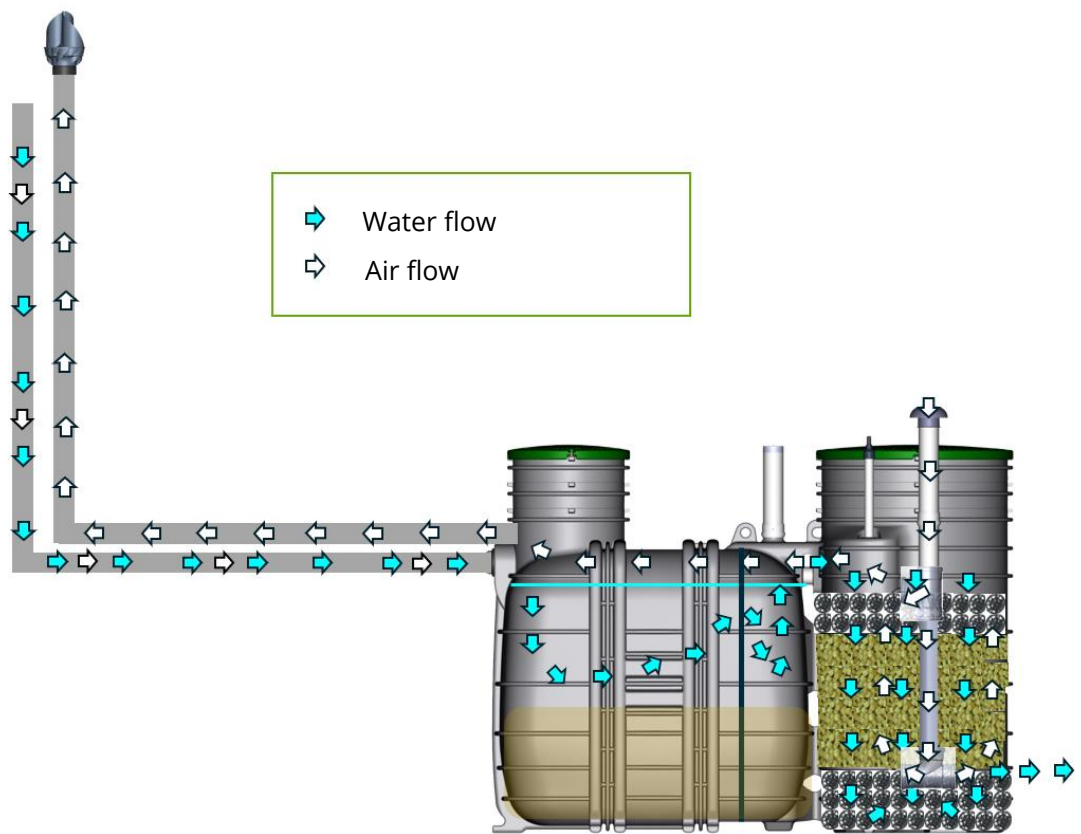

APPENDIX

4

MAINTENANCE AND FOLLOW-UP

TO BE COMPLETED – TO BE KEPT BY THE USER

DATE OF FIRST START-UP: / /

Write down the serial number of the tank (see page 10 of the Guide)

Attention: Keep the draining vouchers validated by the drainer.

DATE	NATURE OF THE SERVICES or REMARKS ON THE INSTALLATION		NAME AND VISA OF THE PROVIDER	COMMENTS
	Maintenance operations performed	Emptying operations (date, volume emptied)		

It is recommended to call upon a qualified professional for the maintenance work and for any intervention to be carried out on the non collective sanitation equipment.

Important Information: If this form isn't returned to BIOROCK within 120 days the installation of the system, there will be no warranty at the system

INSTALLATION FORM FOR A BIOROCK SYSTEM

This form must be completed and returned to:
 BIOROCK S.a.r.l.
 Z.A.E. Le Triangle Vert
 L-5691 ELLANGE (Luxembourg) or by e-mail :**aftersales@biorock.com**
 Or fill in the form on our website: <https://sav.biorock.com/>
PLEASE KEEP ONE COPY FOR YOURSELVES.

DISTRIBUTOR :
 NAME :
 ADDRESS :

Type of installation:

- MONOBLOCK-2 V3 MONOBLOCK-3 V3
 Other:

Installation date:
 Commissioning date:

Installer

NAME.....
 INITIALS.....
 Address

 TEL. :.....
 E-mail.....

OWNER

Name.....
 Initials.....
 Address

 Tel.....
 E-mail.....
 New built home Existing home

Address of the installation if different than owner

Name.....
 Initials.....
 Address

 Tel.....
 E-mail.....
 New built home Existing home

Please indicate :

- ♦ **Nature of building:** ♦ **Number of rooms :**
- ♦ **Number of occupants :**
- Soil conditions:** Dry High ground water Difficult On a slope..... Other:
- Discharge:** Infiltration Water course Re-use Other:

Type & Capacity of the Primary Tank: **Serial number:**

Type & Capacity of the BIOROCK unit: **Serial number:**

- Ventilation:** Winddriven ventilator Electrical
Pump?: After Primary Tank After BIOROCK Reactor

Declaration :

- The BIOROCK® system is installed and commissioned in accordance with:
- The current legislations stating the technical requirements applicable to domestic sewage treatment plants in the territory where the system has been installed
 - Installation, use and maintenance requirements of the Primary Tank and its Effluent Filter, indicated in the Instruction Manual as provided by your supplier
 - Current installation, use and maintenance requirements of the BIOROCK System

Signed at :..... on Signatures :

The Owner :

Name of the responsible Authority:
 (if applicable)

The installer:

